

This Computer program (including software design, programming structure, graphics, manual, and on-line help) was created and published by STRUCTUREPOINT, formerly the Engineering Software Group of the Portland Cement Association (PCA) for the engineering design and analysis of reinforced concrete walls, tilt-up walls, and precast architectural and load-bearing panels.

While STRUCTUREPOINT has taken every precaution to utilize the existing state-of-the-art and to assure the correctness of the analytical solution techniques used in this program, the responsibilities for modeling the structure, inputting data, applying engineering judgment to evaluate the output, and implementing engineering drawings remain with the structural engineer of record. Accordingly, STRUCTUREPOINT does and must disclaim any and all responsibility for defects or failures of structures in connection with which this program is used.

Neither this manual nor any part of it may be reproduced, edited, transmitted by any means electronic or mechanical or by any information storage and retrieval system, without the written permission of STRUCTUREPOINT, LLC.

All products, corporate names, trademarks, service marks, and trade names referenced in this material are the property of their respective owners and are used only for identification and explanation without intent to infringe. spWall™ is a trademark of STRUCTUREPOINT, LLC.

Table of Contents

Chapter 1 – Introduction.....	1
Program Features.....	1
Program Capacity.....	2
System requirements.....	2
Terms.....	2
Conventions.....	3
Installing, Purchasing and Licensing spWall.....	3
Chapter 2 – Method of Solution	2-1
Global Coordinate System.....	2-1
Mesh Generation.....	2-2
Preparing Input.....	2-2
Plate Element.....	2-3
Stiffener Element.....	2-4
Cracking Coefficients.....	2-5
Types of Loads.....	2-6
Load Cases and Load Combinations.....	2-8
Nodal Restraints and Nodal Springs.....	2-8
Solution.....	2-9
Element Design Forces.....	2-9
Required Reinforcement.....	2-12
Wall Shear Strength.....	2-14
Program Results.....	2-18
References.....	2-19
Chapter 3 – spWall Interface.....	3-1
File Menu.....	3-3
Define Menu.....	3-4
Assign Menu.....	3-5
Solve Menu.....	3-6
View Menu.....	3-6
Options Menu.....	3-7
Help Menu.....	3-7
Right Mouse Button Options.....	3-8

Chapter 4 – Operating spWall	4-1
Creating New Data File	4-1
Opening Existing Data File	4-1
Saving Data	4-2
Reverting to Last Saved Data File	4-3
Printing Results	4-3
Printing the Screen.....	4-4
Exporting Wall Elevation to DXF File	4-5
Exiting the Program.....	4-5
Defining Project Description	4-5
Defining Grid.....	4-6
Defining Properties.....	4-9
Defining Supports.....	4-15
Defining Loads	4-16
Defining Load Combinations	4-19
Assigning Properties.....	4-21
Assigning Supports.....	4-25
Applying Loads	4-26
Solving the Model	4-28
Viewing Results.....	4-29
Viewing Contours.....	4-31
Viewing Diagrams.....	4-33
Defining Options	4-34
Chapter 5 – Examples.....	5-1
Example 1	5-1
Example 2	5-12
References	5-23
Appendix	A-1
Code Provisions.....	A-1
Import File Formats	A-21
Conversion Factors - English to SI.....	A-23
Conversion Factors - SI to English.....	A-23
Contact Information.....	A-24

License Agreements

STRUCTUREPOINT EVALUATION SOFTWARE LICENSE AGREEMENT

BY CLICKING THE "I AGREE" ICON BELOW, OR BY INSTALLING, COPYING, OR OTHERWISE USING THE SOFTWARE OR USER DOCUMENTATION, YOU AGREE TO BE BOUND BY THE TERMS OF THIS AGREEMENT, INCLUDING, BUT NOT LIMITED TO, THE WARRANTY DISCLAIMERS, LIMITATIONS OF LIABILITY AND TERMINATION PROVISIONS BELOW. IF YOU DO NOT AGREE TO THE TERMS OF THIS AGREEMENT, DO NOT INSTALL OR USE THE SOFTWARE OR USER DOCUMENTATION, EXIT THIS APPLICATION NOW AND RETURN THE SOFTWARE AND USER DOCUMENTATION TO STRUCTUREPOINT.

STRUCTUREPOINT, 5420 OLD ORCHARD ROAD, SKOKIE, ILLINOIS 60077, GRANTS THE CUSTOMER A PERSONAL, NONEXCLUSIVE, LIMITED, NONTRANSFERABLE LICENSE TO USE THIS SOFTWARE AND USER DOCUMENTATION SOLELY FOR TRIAL AND EVALUATION PURPOSES ONLY IN ACCORDANCE WITH THE TERMS AND CONDITIONS OF THIS AGREEMENT. SOFTWARE AND USER DOCUMENTATION IS SUPPLIED TO CUSTOMER EITHER BY STRUCTUREPOINT DIRECTLY OR THROUGH AN AUTHORIZED DEALER OF STRUCTUREPOINT (HEREAFTER DEALER).

WHILE STRUCTUREPOINT HAS TAKEN PRECAUTIONS TO ASSURE THE CORRECTNESS OF THE ANALYTICAL SOLUTION AND DESIGN TECHNIQUES USED IN THIS SOFTWARE, IT CANNOT AND DOES NOT GUARANTEE ITS PERFORMANCE, NOR CAN IT OR DOES IT BEAR ANY RESPONSIBILITY FOR DEFECTS OR FAILURES IN STRUCTURES IN CONNECTION WITH WHICH THIS SOFTWARE MAY BE USED. DEALER (IF ANY) HAS NOT PARTICIPATED IN THE DESIGN OR DEVELOPMENT OF THIS SOFTWARE AND NEITHER GUARANTEES THE PERFORMANCE OF THE SOFTWARE NOR BEARS ANY RESPONSIBILITY FOR DEFECTS OR FAILURES IN STRUCTURES IN CONNECTION WITH WHICH THIS SOFTWARE IS USED.

STRUCTUREPOINT AND DEALER (IF ANY) EXPRESSLY DISCLAIM ANY WARRANTY THAT: (A) THE FUNCTIONS CONTAINED IN THE SOFTWARE WILL MEET THE REQUIREMENTS OF CUSTOMER OR OPERATE IN COMBINATIONS THAT MAY BE SELECTED FOR USE BY CUSTOMER; (B) THE OPERATION OF THE SOFTWARE WILL BE FREE OF ALL "BUGS" OR PROGRAM ERRORS; OR (C) THE SOFTWARE CONFORMS TO ANY PERFORMANCE SPECIFICATIONS. CUSTOMER ACKNOWLEDGES THAT STRUCTUREPOINT IS UNDER NO OBLIGATION TO PROVIDE ANY SUPPORT, UPDATES, BUG FIXES OR ERROR CORRECTIONS TO OR FOR THE SOFTWARE OR USER DOCUMENTATION.

THE LIMITED WARRANTIES IN SECTION 6 HEREOF ARE IN LIEU OF ALL OTHER WARRANTIES, EXPRESS OR IMPLIED, INCLUDING, BUT NOT LIMITED TO, ANY IMPLIED WARRANTIES OF NON-INFRINGEMENT, MERCHANTABILITY OR FITNESS FOR A PARTICULAR PURPOSE, EACH OF WHICH IS HEREBY DISCLAIMED. EXCEPT AS SET FORTH IN SECTION 6, THE SOFTWARE AND USER DOCUMENTATION ARE PROVIDED ON AN "AS-IS" BASIS.

IN NO EVENT SHALL STRUCTUREPOINT OR DEALER (IF ANY) BE LIABLE FOR: (A) LOSS OF PROFITS, DIRECT, INDIRECT, INCIDENTAL, SPECIAL, EXEMPLARY, PUNITIVE, CONSEQUENTIAL OR OTHER DAMAGES, EVEN IF STRUCTUREPOINT OR DEALER (IF ANY) HAS BEEN ADVISED OF THE POSSIBILITY OF SUCH DAMAGES; (B) ANY CLAIM AGAINST CUSTOMER BY ANY THIRD PARTY; OR (C) ANY DAMAGES CAUSED BY (1) DELAY IN DELIVERY OF THE SOFTWARE OR USER DOCUMENTATION UNDER THIS AGREEMENT; (2) THE PERFORMANCE OR NON PERFORMANCE OF THE SOFTWARE; (3) RESULTS FROM USE OF THE SOFTWARE OR USER DOCUMENTATION, INCLUDING, WITHOUT LIMITATION, MISTAKES, ERRORS, INACCURACIES, FAILURES OR CUSTOMER'S INABILITY TO PROVIDE SERVICES TO THIRD PARTIES THROUGH USE OF THE SOFTWARE OR USER DOCUMENTATION; (4) CUSTOMER'S FAILURE TO PERFORM CUSTOMER'S RESPONSIBILITIES; (5) STRUCTUREPOINT NOT PROVIDING UPDATES, BUG FIXES OR CORRECTIONS TO OR FOR ANY OF THE SOFTWARE OR USER DOCUMENTATION; (6) LABOR, EXPENSE OR MATERIALS NECESSARY TO REPAIR DAMAGE TO THE SOFTWARE OR USER DOCUMENTATION CAUSED BY (a) ACCIDENT, (b) NEGLIGENCE OR ABUSE BY CUSTOMER, (c) ACTS OF THIRD PERSONS INCLUDING, BUT NOT LIMITED TO, INSTALLATION, REPAIR, MAINTENANCE OR OTHER CORRECTIVE WORK RELATED TO ANY EQUIPMENT BEING USED, (d) CAUSES EXTERNAL TO THE SOFTWARE SUCH AS POWER FLUCTUATION AND FAILURES, OR (e) FLOODS, WINDSTORMS OR OTHER ACTS OF GOD. MOREOVER, IN NO EVENT SHALL STRUCTUREPOINT BE LIABLE FOR WARRANTIES, GUARANTEES, REPRESENTATIONS OR ANY OTHER UNDERSTANDINGS BETWEEN CUSTOMER AND DEALER (IF ANY) RELATING TO THE SOFTWARE OR USER DOCUMENTATION.

THIS AGREEMENT CONSTITUTES THE ENTIRE AND EXCLUSIVE AGREEMENT BETWEEN CUSTOMER AND STRUCTUREPOINT AND DEALER (IF ANY) WITH RESPECT TO THE SOFTWARE AND USER DOCUMENTATION TO BE FURNISHED HEREUNDER. IT IS A FINAL EXPRESSION OF THAT AGREEMENT AND UNDERSTANDING. IT SUPERSEDES ALL PRIOR COMMUNICATIONS BETWEEN THE PARTIES (INCLUDING ANY EVALUATION LICENSE AND ALL ORAL AND WRITTEN PROPOSALS). ORAL STATEMENTS MADE BY STRUCTUREPOINT'S OR DEALER'S (IF ANY) REPRESENTATIVES ABOUT THE SOFTWARE OR USER DOCUMENTATION DO NOT CONSTITUTE REPRESENTATIONS OR WARRANTIES, SHALL NOT BE RELIED ON BY CUSTOMER, AND ARE NOT PART OF THIS AGREEMENT.

1. LICENSE RESTRICTIONS

- a. Except as expressly provided in this Agreement or as otherwise authorized in writing by STRUCTUREPOINT, Customer has no right to: (1) use, print, copy, display, reverse assemble, reverse engineer, translate or decompile the Software or User Documentation in whole or in part; (2) disclose, publish, release, sublicense or transfer to another person any Software or User Documentation; (3) reproduce the Software or User Documentation for the use or benefit of anyone other than Customer; or (4) modify any Software or User Documentation. All rights to the Software and User Documentation not expressly granted to

Customer hereunder are retained by STRUCTUREPOINT. All copyrights and other proprietary rights except as expressed elsewhere in the Software or User Documentation and legal title thereto shall remain in STRUCTUREPOINT. Customer may use the Software only as licensed by STRUCTUREPOINT on designated workstation at Customer's site at any given time. Customer may not transmit the Software licenses electronically to any other workstation, computer, node or terminal device whether via a local area network, a wide area network, telecommunications transmission, the Internet or other means now known or hereafter created without prior written permission by STRUCTUREPOINT.

- b. Customer acknowledges that this is a limited license for trial and evaluation purposes only. This limited license shall automatically terminate upon the earlier of: (1) ten executions of the Software on the computer on which it is installed; or (2) fifteen days after the installation of the Software. Thereafter, Customer may only use the Software and Documentation if it acquires a production license for the same.

2. TERM AND TERMINATION

- a. This Agreement shall be in effect from the date Customer clicks the "I AGREE" icon below or installs, copies or otherwise uses the Software or User Documentation until: (1) it is terminated by Customer, by Dealer (if any) on behalf of Customer or STRUCTUREPOINT or by STRUCTUREPOINT as set forth herein; or (2) the limited trial and evaluation license terminates.
- b. This Agreement may be terminated by STRUCTUREPOINT without cause upon 30 days' written notice or immediately upon notice to Customer if Customer breaches this Agreement or fails to comply with any of its terms or conditions. This Agreement may be terminated by Customer without cause at any time upon written notice to STRUCTUREPOINT.

3. BACKUP AND REPLACEMENT COPIES

Customer may make one copy of the Software for back-up and archival purposes only, provided STRUCTUREPOINT's copyright and other proprietary rights notices are included on such copy.

4. PROTECTION AND SECURITY

- a. Customer shall not provide or otherwise make available any of the Software or User Documentation in any form to any person other than employees of Customer with the need to know, without STRUCTUREPOINT's written permission.
- b. All Software and User Documentation in Customer's possession including, without limitation, translations, compilations, back-up, and partial copies is the property of STRUCTUREPOINT. Upon termination of this Agreement for any reason, Customer shall immediately destroy all Software and User Documentation, including all media, and destroy any Software that has been copied onto other magnetic storage devices. Upon STRUCTUREPOINT's request, Customer shall certify its compliance in writing with the foregoing to STRUCTUREPOINT.
- c. Customer shall take appropriate action, by instruction, agreement or otherwise, with any persons permitted access to the Software or User Documentation, to enable Customer to satisfy its obligations under this Agreement with respect to use, copying, protection, and security of the same.
- d. If STRUCTUREPOINT prevails in an action against Customer for breach of the provisions of this Section 4, Customer shall pay the reasonable attorneys' fees, costs, and expenses incurred by STRUCTUREPOINT in connection with such action in addition to any award of damages.

5. CUSTOMER'S RESPONSIBILITIES

The essential purpose of this Agreement is to provide Customer with limited use rights to the Software and User Documentation. Customer accepts full responsibility for: (a) selection of the Software and User Documentation to satisfy Customer's business needs and achieve Customer's intended results; (b) the use, set-up and installation of the Software and User Documentation; (c) all results obtained from use of the Software and User Documentation; and (d) the selection, use of, and results obtained from any other software, programming equipment or services used with the Software or User Documentation.

6. LIMITED WARRANTIES

STRUCTUREPOINT and Dealer (if any) warrants to Customer that: (a) STRUCTUREPOINT and Dealer (if any) has title to the Software and User Documentation and/or the right to grant Customer the rights granted hereunder; (b) the Software and User Documentation provided hereunder is STRUCTUREPOINT's most current production version thereof; and (c) the copy of the Software provided hereunder is an accurate reproduction of the original from which it was made.

7. LIMITATION OF REMEDY

- a. **STRUCTUREPOINT AND DEALER (IF ANY) HAS NO LIABILITY UNDER THIS AGREEMENT. CUSTOMER'S EXCLUSIVE REMEDY FOR DAMAGES DUE TO PERFORMANCE OR NONPERFORMANCE OF ANY SOFTWARE OR USER DOCUMENTATION, STRUCTUREPOINT, DEALER (IF ANY), OR ANY OTHER CAUSE WHATSOEVER, AND REGARDLESS OF THE FORM OF ACTION, WHETHER IN CONTRACT OR IN TORT, INCLUDING NEGLIGENCE, SHALL BE LIMITED TO CUSTOMER STOPPING ALL USE OF THE SOFTWARE AND USER DOCUMENTATION AND RETURNING THE SAME TO STRUCTUREPOINT.**
- b. **NEITHER STRUCTUREPOINT NOR DEALER (IF ANY) IS AN INSURER WITH REGARD TO THE PERFORMANCE OF THE SOFTWARE OR USER DOCUMENTATION. THE TERMS OF THIS AGREEMENT, INCLUDING, BUT NOT LIMITED TO, THE LIMITED WARRANTIES, AND THE LIMITATION OF LIABILITY AND REMEDY, ARE A REFLECTION OF THE RISKS ASSUMED BY THE PARTIES. IN ORDER TO OBTAIN**

THE SOFTWARE AND USER DOCUMENTATION FROM STRUCTUREPOINT OR DEALER (IF ANY), CUSTOMER HEREBY ASSUMES THE RISKS FOR (1) ALL LIABILITIES DISCLAIMED BY STRUCTUREPOINT AND DEALER (IF ANY) ON THE FACE HEREOF; AND (2) ALL ACTUAL OR ALLEGED DAMAGES IN CONNECTION WITH THE USE OF THE SOFTWARE AND USER DOCUMENTATION. THE ESSENTIAL PURPOSE OF THE LIMITED REMEDY PROVIDED CUSTOMER HEREUNDER IS TO ALLOCATE THE RISKS AS PROVIDED ABOVE.

8. U.S. GOVERNMENT RESTRICTED RIGHTS

This commercial computer software and commercial computer software documentation were developed exclusively at private expense by STRUCTUREPOINT, 5420 Old Orchard Road, Skokie, Illinois, 60077. U.S. Government rights to use, modify, release, reproduce, perform, display or disclose this computer software and computer software documentation are subject to the restrictions of DFARS 227.7202-1(a) (September 2007) and DFARS 227.7202-3(a) (September 2007), or the Restricted Rights provisions of FAR 52.227-14 (December 2007) and FAR 52.227-19 (December 2007), as applicable.

9. GENERAL

- a. No action arising out of any claimed breach of this Agreement or transactions under this Agreement may be brought by Customer more than two years after the cause of such action has arisen.
- b. Customer may not assign, sell, sublicense or otherwise transfer this Agreement, the license granted herein or the Software or User Documentation by operation of law or otherwise without the prior written consent of STRUCTUREPOINT. Any attempt to do any of the foregoing without STRUCTUREPOINT's consent is void.
- c. Customer acknowledges that the Software, User Documentation and other proprietary information and materials of STRUCTUREPOINT are unique and that, if Customer breaches this Agreement, STRUCTUREPOINT may not have an adequate remedy at law and STRUCTUREPOINT may enforce its rights hereunder by an action for damages and/or injunctive or other equitable relief without the necessity of proving actual damage or posting a bond therefor.
- d. E. THE RIGHTS AND OBLIGATIONS UNDER THIS AGREEMENT SHALL NOT BE GOVERNED BY THE UNITED NATIONS CONVENTION ON CONTRACTS FOR THE INTERNATIONAL SALE OF GOODS, THE APPLICATION OF WHICH IS EXPRESSLY EXCLUDED, BUT SUCH RIGHTS AND OBLIGATIONS SHALL INSTEAD BE GOVERNED BY THE LAWS OF THE STATE OF ILLINOIS, APPLICABLE TO CONTRACTS ENTERED INTO AND PERFORMED ENTIRELY WITHIN THE STATE OF ILLINOIS AND APPLICABLE FEDERAL (U.S.) LAWS. UCITA SHALL NOT APPLY TO THIS AGREEMENT.
- e. G. THIS AGREEMENT SHALL BE TREATED AS THOUGH IT WERE EXECUTED IN THE COUNTY OF COOK, STATE OF ILLINOIS, AND WAS TO HAVE BEEN PERFORMED IN THE COUNTY OF COOK, STATE OF ILLINOIS. ANY ACTION RELATING TO THIS AGREEMENT SHALL BE INSTITUTED AND PROSECUTED IN A COURT LOCATED IN COOK COUNTY, ILLINOIS. CUSTOMER SPECIFICALLY CONSENTS TO EXTRATERRITORIAL SERVICE OF PROCESS.
- f. Except as prohibited elsewhere in this Agreement, this Agreement shall be binding upon and inure to the benefit of the personal and legal representatives, permitted successors, and permitted assigns of the parties hereto.
- g. All notices, demands, consents or requests that may be or are required to be given by any party to another party shall be in writing. All notices, demands, consents or requests given by the parties hereto shall be sent either by U.S. certified mail, postage prepaid or by an overnight international delivery service, addressed to the respective parties. Notices, demands, consents or requests served as set forth herein shall be deemed sufficiently served or given at the time of receipt thereof.
- h. The various rights, options, elections, powers, and remedies of a party or parties to this Agreement shall be construed as cumulative and no one of them exclusive of any others or of any other legal or equitable remedy that said party or parties might otherwise have in the event of breach or default in the terms hereof. The exercise of one right or remedy by a party or parties shall not in any way impair its rights to any other right or remedy until all obligations imposed on a party or parties have been fully performed.
- i. No waiver by Customer, STRUCTUREPOINT or Dealer (if any) of any breach, provision, or default by the other shall be deemed a waiver of any other breach, provision or default.
- j. The parties hereto, and each of them, agree that the terms of this Agreement shall be given a neutral interpretation and any ambiguity or uncertainty herein should not be construed against any party hereto.
- k. If any provision of this Agreement or portion thereof is held to be unenforceable or invalid by any court or competent jurisdiction, such decision shall not have the effect of invalidating or voiding the remainder of this Agreement, it being the intent and agreement of the parties that this Agreement shall be deemed amended by modifying such provision to the extent necessary to render it enforceable and valid while preserving its intent or, if such modification is not possible, by substituting therefor another provision that is enforceable and valid so as to materially effectuate the parties' intent.

Except as set forth herein, this Agreement may be modified or amended only by a written instrument signed by a duly authorized representative of STRUCTUREPOINT and Customer.

STRUCTUREPOINT SOFTWARE LICENSE AGREEMENT

BY CLICKING THE "I AGREE" BELOW, OR BY INSTALLING, COPYING, OR OTHERWISE USING THE SOFTWARE OR USER DOCUMENTATION, YOU AGREE TO BE BOUND BY THE TERMS OF THIS AGREEMENT, INCLUDING, BUT NOT LIMITED TO, THE WARRANTY DISCLAIMERS, LIMITATIONS OF LIABILITY AND TERMINATION PROVISIONS BELOW. IF YOU DO NOT AGREE TO THE TERMS OF THIS AGREEMENT, DO NOT INSTALL OR USE THE SOFTWARE OR USER DOCUMENTATION, EXIT THIS APPLICATION NOW AND RETURN THE SOFTWARE AND USER DOCUMENTATION TO STRUCTUREPOINT FOR A FULL REFUND WITHIN THIRTY DAYS AFTER YOUR RECEIPT OF THE SOFTWARE AND USER DOCUMENTATION.

STRUCTUREPOINT, 5420 OLD ORCHARD ROAD, SKOKIE, ILLINOIS 60077, GRANTS THE CUSTOMER A PERSONAL, NONEXCLUSIVE, LIMITED, NONTRANSFERABLE LICENSE TO USE THIS SOFTWARE AND USER DOCUMENTATION IN ACCORDANCE WITH THE TERMS AND CONDITIONS OF THIS AGREEMENT. SOFTWARE AND USER DOCUMENTATION IS SUPPLIED TO CUSTOMER EITHER BY STRUCTUREPOINT DIRECTLY OR THROUGH AN AUTHORIZED DEALER OF STRUCTUREPOINT (HEREAFTER DEALER).

WHILE STRUCTUREPOINT HAS TAKEN PRECAUTIONS TO ASSURE THE CORRECTNESS OF THE ANALYTICAL SOLUTION AND DESIGN TECHNIQUES USED IN THIS SOFTWARE, IT CANNOT AND DOES NOT GUARANTEE ITS PERFORMANCE, NOR CAN IT OR DOES IT BEAR ANY RESPONSIBILITY FOR DEFECTS OR FAILURES IN STRUCTURES IN CONNECTION WITH WHICH THIS SOFTWARE IS USED. DEALER (IF ANY) HAS NOT PARTICIPATED IN THE DESIGN OR DEVELOPMENT OF THIS SOFTWARE AND NEITHER GUARANTEES THE PERFORMANCE OF THE SOFTWARE NOR BEARS ANY RESPONSIBILITY FOR DEFECTS OR FAILURES IN STRUCTURES IN CONNECTION WITH WHICH THIS SOFTWARE IS USED.

STRUCTUREPOINT AND DEALER (IF ANY) EXPRESSLY DISCLAIM ANY WARRANTY THAT: (A) THE FUNCTIONS CONTAINED IN THE SOFTWARE WILL MEET THE REQUIREMENTS OF CUSTOMER OR OPERATE IN COMBINATIONS THAT MAY BE SELECTED FOR USE BY CUSTOMER; (B) THE OPERATION OF THE SOFTWARE WILL BE FREE OF ALL "BUGS" OR PROGRAM ERRORS; OR (C) THE SOFTWARE CONFORMS TO ANY PERFORMANCE SPECIFICATIONS. CUSTOMER ACKNOWLEDGES THAT STRUCTUREPOINT IS UNDER NO OBLIGATION TO PROVIDE ANY SUPPORT, UPDATES, BUG FIXES OR ERROR CORRECTIONS TO OR FOR THE SOFTWARE OR USER DOCUMENTATION.

THE LIMITED WARRANTIES IN SECTION 7 HEREOF ARE IN LIEU OF ALL OTHER WARRANTIES, EXPRESS OR IMPLIED, INCLUDING, BUT NOT LIMITED TO, ANY IMPLIED WARRANTIES OF NON-INFRINGEMENT, MERCHANTABILITY OR FITNESS FOR A PARTICULAR PURPOSE, EACH OF WHICH IS HEREBY DISCLAIMED. EXCEPT AS SET FORTH IN SECTION 7, THE SOFTWARE AND USER DOCUMENTATION ARE PROVIDED ON AN "AS-IS" BASIS.

IN NO EVENT SHALL STRUCTUREPOINT OR DEALER (IF ANY) BE LIABLE FOR: (A) LOSS OF PROFITS, INDIRECT, INCIDENTAL, SPECIAL, EXEMPLARY, PUNITIVE, CONSEQUENTIAL OR OTHER DAMAGES, EVEN IF STRUCTUREPOINT OR DEALER (IF ANY) HAS BEEN ADVISED OF THE POSSIBILITY OF SUCH DAMAGES; (B) ANY CLAIM AGAINST CUSTOMER BY ANY THIRD PARTY EXCEPT AS PROVIDED IN SECTION 8 ENTITLED "INFRINGEMENT"; OR (C) ANY DAMAGES CAUSED BY (1) DELAY IN DELIVERY OF THE SOFTWARE OR USER DOCUMENTATION UNDER THIS AGREEMENT; (2) THE PERFORMANCE OR NONPERFORMANCE OF THE SOFTWARE; (3) RESULTS FROM USE OF THE SOFTWARE OR USER DOCUMENTATION, INCLUDING, WITHOUT LIMITATION, MISTAKES, ERRORS, INACCURACIES, FAILURES OR CUSTOMER'S INABILITY TO PROVIDE SERVICES TO THIRD PARTIES THROUGH USE OF THE SOFTWARE OR USER DOCUMENTATION; (4) CUSTOMER'S FAILURE TO PERFORM CUSTOMER'S RESPONSIBILITIES; (5) STRUCTUREPOINT NOT PROVIDING UPDATES, BUG FIXES OR CORRECTIONS TO OR FOR ANY OF THE SOFTWARE OR USER DOCUMENTATION; (6) LABOR, EXPENSE OR MATERIALS NECESSARY TO REPAIR DAMAGE TO THE SOFTWARE OR USER DOCUMENTATION CAUSED BY (a) ACCIDENT, (b) NEGLIGENCE OR ABUSE BY CUSTOMER, (c) ACTS OF THIRD PERSONS INCLUDING, BUT NOT LIMITED TO, INSTALLATION, REPAIR, MAINTENANCE OR OTHER CORRECTIVE WORK RELATED TO ANY EQUIPMENT BEING USED, (d) CAUSES EXTERNAL TO THE SOFTWARE SUCH AS POWER FLUCTUATION AND FAILURES, OR (e) FLOODS, WINDSTORMS OR OTHER ACTS OF GOD. MOREOVER, IN NO EVENT SHALL STRUCTUREPOINT BE LIABLE FOR WARRANTIES, GUARANTEES, REPRESENTATIONS OR ANY OTHER UNDERSTANDINGS BETWEEN CUSTOMER AND DEALER (IF ANY) RELATING TO THE SOFTWARE OR USER DOCUMENTATION.

THIS AGREEMENT CONSTITUTES THE ENTIRE AND EXCLUSIVE AGREEMENT BETWEEN CUSTOMER AND STRUCTUREPOINT AND DEALER (IF ANY) WITH RESPECT TO THE SOFTWARE AND USER DOCUMENTATION TO BE FURNISHED HEREUNDER. IT IS A FINAL EXPRESSION OF THAT AGREEMENT AND UNDERSTANDING. IT SUPERSEDES ALL PRIOR COMMUNICATIONS BETWEEN THE PARTIES (INCLUDING ANY EVALUATION LICENSE AND ALL ORAL AND WRITTEN PROPOSALS). ORAL STATEMENTS MADE BY STRUCTUREPOINT 'S OR DEALER'S (IF ANY) REPRESENTATIVES ABOUT THE SOFTWARE OR USER DOCUMENTATION DO NOT CONSTITUTE REPRESENTATIONS OR WARRANTIES, SHALL NOT BE RELIED ON BY CUSTOMER, AND ARE NOT PART OF THIS AGREEMENT.

1. LICENSE RESTRICTIONS

- a. Except as expressly provided in this Agreement or as otherwise authorized in writing by STRUCTUREPOINT, Customer has no right to: (1) use, print, copy, display, reverse assemble, reverse engineer, translate or decompile the Software or User Documentation in whole or in part; (2) disclose, publish, release, sublicense or transfer to another person any Software or User Documentation; (3) reproduce the Software or User Documentation for the use or benefit of anyone other than Customer; or (4) modify any Software or User Documentation. All rights to the Software and User Documentation not expressly granted to Customer hereunder are retained by STRUCTUREPOINT. All copyrights and other proprietary rights except as expressed

elsewhere in the Software or User Documentation and legal title thereto shall remain in STRUCTUREPOINT. Customer may use the Software only as licensed by STRUCTUREPOINT on designated workstation at Customer's site at any given time. Customer may not transmit the Software licenses electronically to any other workstation, computer, node or terminal device whether via a local area network, a wide area network, telecommunications transmission, the Internet or other means now known or hereafter created without prior written permission by STRUCTUREPOINT.

- b. Customer acknowledges that the registration process for the Software results in the generation of a unique license code. Once the license code is entered DURING THE INSTALLATION PROCESS, the Software will only work on the computer on which the Software LICENSE is INITIALLY installed. If you need to deinstall the Software license and reinstall the Software license on a different computer, you must contact STRUCTUREPOINT to obtain the necessary reinstallation procedures.

2. CHARGES AND PAYMENTS

All payments for the Software and User Documentation shall be made to either STRUCTUREPOINT or Dealer (if any), as appropriate.

3. TERM AND TERMINATION

- a. This Agreement shall be in effect from the date Customer clicks the "I AGREE" below or installs, copies or otherwise uses the Software or User Documentation until it is terminated by Customer, by Dealer (if any) on behalf of Customer or STRUCTUREPOINT or by STRUCTUREPOINT as set forth herein.
- b. This Agreement may be terminated by STRUCTUREPOINT without cause upon 30 days' written notice or immediately upon notice to Customer if Customer breaches this Agreement or fails to comply with any of its terms or conditions. This Agreement may be terminated by Customer without cause at any time upon written notice to STRUCTUREPOINT.

4. BACKUP AND REPLACEMENT COPIES

Customer may make one copy of the Software for back-up and archival purposes only, provided STRUCTUREPOINT's copyright and other proprietary rights notices are included on such copy.

5. PROTECTION AND SECURITY

- a. Customer shall not provide or otherwise make available any of the Software or User Documentation in any form to any person other than employees of Customer with the need to know, without STRUCTUREPOINT's written permission.
- b. All Software and User Documentation in Customer's possession including, without limitation, translations, compilations, back-up, and partial copies is the property of STRUCTUREPOINT. Upon termination of this Agreement for any reason, Customer shall immediately destroy all Software and User Documentation, including all media, and destroy any Software that has been copied onto other magnetic storage devices. Upon STRUCTUREPOINT's request, Customer shall certify its compliance in writing with the foregoing to STRUCTUREPOINT.
- c. Customer shall take appropriate action, by instruction, agreement or otherwise, with any persons permitted access to the Software or User Documentation, to enable Customer to satisfy its obligations under this Agreement with respect to use, copying, protection, and security of the same.
- d. If STRUCTUREPOINT prevails in an action against Customer for breach of the provisions of this Section 5, Customer shall pay the reasonable attorneys' fees, costs, and expenses incurred by STRUCTUREPOINT in connection with such action in addition to any award of damages.

6. CUSTOMER'S RESPONSIBILITIES

The essential purpose of this Agreement is to provide Customer with limited use rights to the Software and User Documentation. Customer accepts full responsibility for: (a) selection of the Software and User Documentation to satisfy Customer's business needs and achieve Customer's intended results; (b) the use, set-up and installation of the Software and User Documentation; (c) all results obtained from use of the Software and User Documentation; and (d) the selection, use of, and results obtained from any other software, programming equipment or services used with the Software or User Documentation.

7. LIMITED WARRANTIES

STRUCTUREPOINT and Dealer (if any) warrants to Customer that: (a) STRUCTUREPOINT and Dealer (if any) has title to the Software and User Documentation and/or the right to grant Customer the rights granted hereunder; (b) the Software and User Documentation provided hereunder is STRUCTUREPOINT's most current production version thereof; and (c) the copy of the Software provided hereunder is an accurate reproduction of the original from which it was made.

8. INFRINGEMENT

- a. STRUCTUREPOINT shall defend Customer against a claim that the Software or User Documentation furnished and used within the scope of the license granted hereunder infringes a U.S. patent or U.S. registered copyright of any third party that was issued or registered, as applicable, as of the date Customer clicked the "I AGREE" below or installed, copied or otherwise began using the Software or User Documentation, and STRUCTUREPOINT shall pay resulting costs, damages, and attorneys' fees finally awarded, subject to the limitation of liability set forth in Section 9 entitled "Limitation of Remedy," provided that:
 1. Customer promptly notifies STRUCTUREPOINT in writing of the claim.
 2. STRUCTUREPOINT has sole control of the defense and all related settlement negotiations.
 3. If such claim has occurred or in STRUCTUREPOINT's opinion is likely to occur, Customer shall permit

STRUCTUREPOINT at its sole option and expense either to procure for Customer the right to continue using the Software or User Documentation or to replace or modify the same so that it becomes noninfringing. If neither of the foregoing alternatives is reasonably available in STRUCTUREPOINT's sole judgment, Customer shall, on one month's written notice from STRUCTUREPOINT, return to STRUCTUREPOINT the Software and User Documentation and all copies thereof.

- b. STRUCTUREPOINT shall have no obligation to defend Customer or to pay costs, damages or attorneys' fees for any claim based upon (1) use of other than a current unaltered release of the Software or User Documentation, or (2) the combination, operation or use of any Software or User Documentation furnished hereunder with any other software, documentation or data if such infringement would have been avoided but for the combination, operation or use of the Software or User Documentation with other software, documentation or data.
- c. The foregoing states the entire obligation of STRUCTUREPOINT and Customer's sole remedy with respect to infringement matters relating to the Software and User Documentation.

9. LIMITATION OF REMEDY

- a. **STRUCTUREPOINT'S AND DEALER'S (IF ANY) ENTIRE LIABILITY AND CUSTOMER'S EXCLUSIVE REMEDY FOR DAMAGES DUE TO PERFORMANCE OR NONPERFORMANCE OF ANY SOFTWARE OR USER DOCUMENTATION, STRUCTUREPOINT, DEALER (IF ANY), OR ANY OTHER CAUSE WHATSOEVER, AND REGARDLESS OF THE FORM OF ACTION, WHETHER IN CONTRACT OR IN TORT, INCLUDING NEGLIGENCE, SHALL BE LIMITED TO THE AMOUNT PAID TO STRUCTUREPOINT OR DEALER (IF ANY) FOR THE SOFTWARE AND USER DOCUMENTATION.**
- b. **NEITHER STRUCTUREPOINT NOR DEALER (IF ANY) IS AN INSURER WITH REGARD TO THE PERFORMANCE OF THE SOFTWARE OR USER DOCUMENTATION. THE TERMS OF THIS AGREEMENT, INCLUDING, BUT NOT LIMITED TO, THE LIMITED WARRANTIES, AND THE LIMITATION OF LIABILITY AND REMEDY, ARE A REFLECTION OF THE RISKS ASSUMED BY THE PARTIES. IN ORDER TO OBTAIN THE SOFTWARE AND USER DOCUMENTATION FROM STRUCTUREPOINT OR DEALER (IF ANY), CUSTOMER HEREBY ASSUMES THE RISKS FOR (1) ALL LIABILITIES DISCLAIMED BY STRUCTUREPOINT AND DEALER (IF ANY) ON THE FACE HEREOF; AND (2) ALL ACTUAL OR ALLEGED DAMAGES IN EXCESS OF THE AMOUNT OF THE LIMITED REMEDY PROVIDED HEREUNDER. THE ESSENTIAL PURPOSE OF THE LIMITED REMEDY PROVIDED CUSTOMER HEREUNDER IS TO ALLOCATE THE RISKS AS PROVIDED ABOVE.**

10. U.S. GOVERNMENT RESTRICTED RIGHTS

This commercial computer software and commercial computer software documentation were developed exclusively at private expense by STRUCTUREPOINT, 5420 Old Orchard Road, Skokie, Illinois 60077. U.S. Government rights to use, modify, release, reproduce, perform, display or disclose this computer software and computer software documentation are subject to the restrictions of DFARS 227.7202-1(a) (September 2007) and DFARS 227.7202-3(a) (September 2007), or the Restricted Rights provisions of FAR 52.227-14 (December 2007) and FAR 52.227-19 (December 2007), as applicable.

11. GENERAL

- a. No action arising out of any claimed breach of this Agreement or transactions under this Agreement may be brought by Customer more than two years after the cause of such action has arisen.
- b. Customer may not assign, sell, sublicense or otherwise transfer this Agreement, the license granted herein or the Software or User Documentation by operation of law or otherwise without the prior written consent of STRUCTUREPOINT. Any attempt to do any of the foregoing without STRUCTUREPOINT's consent is void.
- c. Customer acknowledges that the Software, User Documentation and other proprietary information and materials of STRUCTUREPOINT are unique and that, if Customer breaches this Agreement, STRUCTUREPOINT may not have an adequate remedy at law and STRUCTUREPOINT may enforce its rights hereunder by an action for damages and/or injunctive or other equitable relief without the necessity of proving actual damage or posting a bond therefor.
- d. THE RIGHTS AND OBLIGATIONS UNDER THIS AGREEMENT SHALL NOT BE GOVERNED BY THE UNITED NATIONS CONVENTION ON CONTRACTS FOR THE INTERNATIONAL SALE OF GOODS, THE APPLICATION OF WHICH IS EXPRESSLY EXCLUDED, BUT SUCH RIGHTS AND OBLIGATIONS SHALL INSTEAD BE GOVERNED BY THE LAWS OF THE STATE OF ILLINOIS, APPLICABLE TO CONTRACTS ENTERED INTO AND PERFORMED ENTIRELY WITHIN THE STATE OF ILLINOIS AND APPLICABLE FEDERAL (U.S.) LAWS. UCITA SHALL NOT APPLY TO THIS AGREEMENT.
- e. THIS AGREEMENT SHALL BE TREATED AS THOUGH IT WERE EXECUTED IN THE COUNTY OF COOK, STATE OF ILLINOIS, AND WAS TO HAVE BEEN PERFORMED IN THE COUNTY OF COOK, STATE OF ILLINOIS. ANY ACTION RELATING TO THIS AGREEMENT SHALL BE INSTITUTED AND PROSECUTED IN A COURT LOCATED IN COOK COUNTY, ILLINOIS. CUSTOMER SPECIFICALLY CONSENTS TO EXTRATERRITORIAL SERVICE OF PROCESS.
- f. Except as prohibited elsewhere in this Agreement, this Agreement shall be binding upon and inure to the benefit of the personal and legal representatives, permitted successors, and permitted assigns of the parties hereto.
- g. All notices, demands, consents or requests that may be or are required to be given by any party to another party shall be in writing. All notices, demands, consents or requests given by the parties hereto shall be sent either by U.S. certified mail,

postage prepaid or by an overnight international delivery service, addressed to the respective parties. Notices, demands, consents or requests served as set forth herein shall be deemed sufficiently served or given at the time of receipt thereof.

- h. The various rights, options, elections, powers, and remedies of a party or parties to this Agreement shall be construed as cumulative and no one of them exclusive of any others or of any other legal or equitable remedy that said party or parties might otherwise have in the event of breach or default in the terms hereof. The exercise of one right or remedy by a party or parties shall not in any way impair its rights to any other right or remedy until all obligations imposed on a party or parties have been fully performed.
- i. No waiver by Customer, STRUCTUREPOINT or Dealer (if any) of any breach, provision, or default by the other shall be deemed a waiver of any other breach, provision or default.
- j. The parties hereto, and each of them, agree that the terms of this Agreement shall be given a neutral interpretation and any ambiguity or uncertainty herein should not be construed against any party hereto.
- k. If any provision of this Agreement or portion thereof is held to be unenforceable or invalid by any court or competent jurisdiction, such decision shall not have the effect of invalidating or voiding the remainder of this Agreement, it being the intent and agreement of the parties that this Agreement shall be deemed amended by modifying such provision to the extent necessary to render it enforceable and valid while preserving its intent or, if such modification is not possible, by substituting therefor another provision that is enforceable and valid so as to materially effectuate the parties' intent.

Except as set forth herein, this Agreement may be modified or amended only by a written instrument signed by a duly authorized representative of STRUCTUREPOINT and Customer.

April 2009

spWall is a computer program for design and analysis of reinforced concrete cast-in-place walls, tilt-up walls, ICF walls, and precast architectural and load-bearing panels. It uses a graphical interface that enables the user to easily generate complex wall models. The geometry of the wall (including any number of openings and stiffeners), the material properties, the loads (point, line, and area), and the support conditions are assigned graphically by the user. Also, springs (translational and rotational) can be graphically assigned at any node.

The program is based on the finite element method and can take into account second-order effects. The wall may include any number of openings and stiffeners. The amount of steel required for flexure is computed based on the selected design standard, and the user can specify one or two layers of reinforcement. The program also calculates the amount of steel required for shear and torsion in the stiffeners. The wall shear strength provided by concrete (in-plane and out-of-plane) is calculated allowing the user to determine the need for adding shear capacity.

Program Features

- Support for ACI 318-11/08/05/02 and CSA A23.3-04/94 concrete design standards
- Design of wall flexure and axial reinforcement with one or two reinforcement curtains
- Design of stiffener elements for flexure, shear, and torsion
- Calculation of wall shear strength provided by concrete (in-plane and out-of-plane) in accordance with ACI code
- Finite element analysis (including second order effects) of flat wall panels with stiffeners
- Calculation of wall cross-sectional forces in horizontal sections along wall height
- Arbitrary geometry of wall panels which may include openings
- Import of grid, load, and load combination information from text files to facilitate model generation
- Export of wall view to DXF files for easier integration with drafting and modeling software
- Arbitrary boundary conditions including spring supports
- Point, line, and area load types to model any loading conditions
- Default definitions and assignment of model properties provided to facilitate model generation
- English and metric (SI) units
- Straightforward and effective graphical user interface
- Graphical display of geometry and loads as they are input
- Print preview of graphical screen
- User-controlled screen settings
- Ability to save defaults and settings for future input sessions
- Customizable results report
- Import input data from PCA-Wall v2.0 and pcaWall/spWall v3.x
- Online help and manual

Program Capacity

- 255 X-grid lines
- 255 Y-grid lines
- 255 Plate thickness definitions
- 255 Stiffener section definitions
- 255 Plate cracking coefficient definitions
- 255 Stiffener cracking coefficient definitions
- 255 Concrete definitions
- 255 Reinforcing steel definitions
- 255 Plate design criteria definitions
- 255 Stiffener design criteria definitions
- 255 Rigid support definitions
- 255 Spring support definitions
- 255 Point load definitions per load case
- 255 Uniform line load definitions per load case
- 255 Uniform area load definitions per load case
- 255 Linear area load definitions per load case
- Six basic load cases
- 255 Service Load combinations
- 255 Ultimate Load combinations
- Approximately 10,000 nodes and 10,000 elements

System Requirements

Any computer running Microsoft Windows XP, Windows Vista, or Windows 7 operating system with 32 or 64 bit processing is sufficient to run the spWall program. For instructions on how to troubleshoot system specific installation and licensing issues, please refer to support pages on StructurePoint website at www.StructurePoint.org.

Terms

The following terms are used throughout this manual. A brief explanation is given to help familiarize you with them.

Windows	refers to the Microsoft Windows environment as listed in System Requirements.
[]	indicates metric equivalent
Click on	means to position the cursor on top of a designated item or location and press and release the left-mouse button (unless instructed to use the right-mouse button).
Double-click on	means to position the cursor on top of a designated item or location and press and release the left-mouse button twice in quick succession.

Marquee select means to depress the mouse button and continue to hold it down while moving the mouse. As you drag the mouse, a rectangle (known as a marquee) follows the cursor. Release the mouse button and the area inside the marquee is selected.

Conventions

Various styles of text and layout have been used in this manual to help differentiate between different kinds of information. The styles and layout are explained below...

Italic indicates a glossary item, or emphasizes a given word or phrase.

Bold All bold typeface makes reference to either a menu or a menu item command such as **File** or **Save**, or a tab such as **Description** or **Grid**.

Mono-space indicates something you should enter with the keyboard. For example type "c:\filename.txt".

KEY + KEY indicates a key combination. The plus sign indicates that you should press and hold the first key while pressing the second key, then release both keys. For example, "ALT + F" indicates that you should press the "ALT" key and hold it while you press the "F" key. Then release both keys.

SMALL CAPS Indicates the name of an object such as a dialog box or a dialog box component. For example, the OPEN dialog box or the CANCEL or MODIFY buttons.

Installing, Purchasing and Licensing spWall

For instructions on how to install, purchase, and license StructurePoint software please refer to support pages on StructurePoint website at www.StructurePoint.org.

spWall uses the Finite Element Method for the structural modeling and analysis of slender and non-slender reinforced concrete walls subject to static loading conditions. The wall is idealized as a mesh of rectangular plate elements and straight line stiffener elements. Walls of irregular geometry are idealized to conform to geometry with rectangular boundaries. Plate and stiffener properties can vary from one element to another but are assumed by the program to be uniform within each element.

Six degrees of freedom exist at each node: three translations and three rotations relating to the three Cartesian axes. An external load can exist in the direction of each of the degrees of freedom. Sufficient number of nodal degrees of freedom should be restrained in order to achieve stability of the model.

The program assembles the global stiffness matrix and load vectors for the finite element model. Then, it solves the equilibrium equations to obtain deflections and rotations at each node. Finally, the program calculates the internal forces and internal moments in each element. At the user's option, the program can perform second order analysis. In this case, the program takes into account the effect of in-plane forces on the out-of-plane deflection.

Walls can be designed using simplified methods such as the empirical design method and alternative method provided in ACI 318 and CSA A23.3 standards¹. Such methods are limited to specific wall geometry, loading, and support conditions. Walls that do not meet these limitations are required to be designed as compression members² and slenderness effects in them can be accounted for by performing second-order analysis³. This general approach is implemented in spWall to allow for a wider range of wall configurations and applications.

The program calculates the required amount of reinforcement in the plate elements and stiffener elements based on the code selected by the user. For solid walls, spWall can also compare cross-sectional shear forces with calculated in-plane and out-of plane shear strength provided by concrete.

Global Coordinate System

The mid-surface of the wall lies in the XY plane of the right-handed XYZ rectangular coordinate system shown in Figure 2-1. The wall thickness is measured in the direction of the Z-axis. The positive X-axis points to the right, the positive Y-axis points upward towards the top of the monitor, and positive Z-axis points out of the screen. Thus, the XY plane is defined as being in the plane of the display monitor.

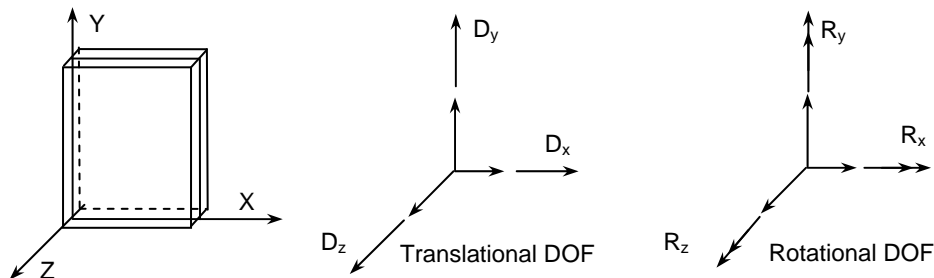

Figure 2-1 Global Coordinate System

¹ ACI 318-11, 14.5, 14.8; ACI 318-08, 14.5, 14.8; ACI 318-05, 14.5, 14.8; ACI 318-02, 14.5, 14.8; CSA A23.3-04, 14.2.2, 23.3; CSA A23.3-94, 14.5, 23.4

² ACI 318-11, 14.4; ACI 318-08, 14.4; ACI 318-05, 14.4; ACI 318-02, 14.4; CSA A23.3-04, 14.2.1; CSA A23.3-94, 14.4

³ ACI 318-11, 10.10.4; ACI 318-08, 10.10.4; ACI 318-05, 10.10.1; ACI 318-02, 10.10.1; CSA A23.3-04, 10.13.1; CSA A23.3-94, 10.13.1

Mesh Generation

The nodal coordinates of the finite element mesh are internally computed by the program based on the rectangular grid system shown in Figure 2-2. A group of grid lines, orthogonal to the X and Y axes, are defined by inputting their coordinates. An X-grid line is a vertical line defined by its distance from the origin along the X-axis and a Y-grid line is a horizontal line defined by its distance from the origin along the Y-axis.

The intersection of two orthogonal grid lines forms a grid intersection. The space formed by the intersection of two consecutive X-grid lines and two consecutive Y-grid lines is a grid space. Assigning plate thicknesses to the grid spaces automatically creates plate finite elements in these grid spaces. The assembling of stiffener elements to the wall system is done by assigning stiffener element section to the lines defined by the connection of two consecutive grid intersections in the X or Y directions.

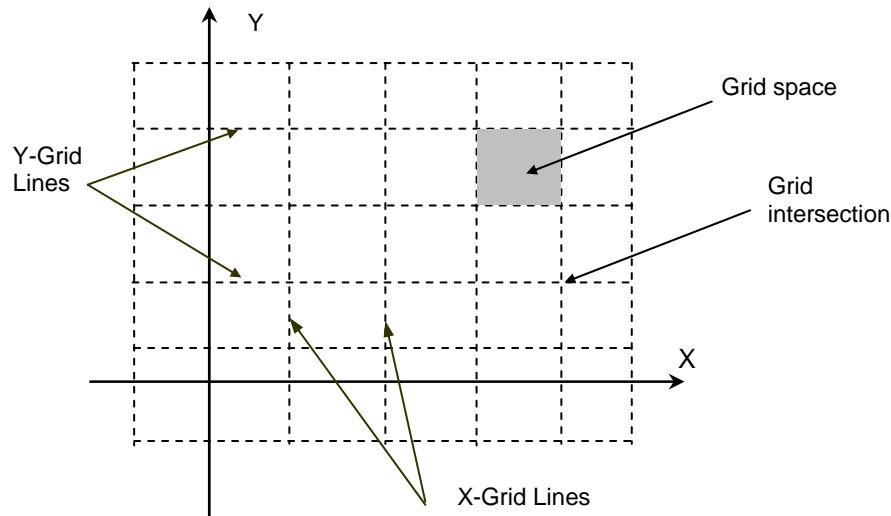

Figure 2-2. The Grid System

Preparing Input

The first step in preparing the input is to draw a scaled elevation view of the wall. The elevation view should include the boundaries of the wall, variations in the wall thickness, material properties, stiffener locations, and openings within the wall. All superimposed loads applied on the wall should also be shown.

Superimpose a rectangular grid system over the elevation of the wall. The following factors control the grid layout:

1. Grid lines must exist along wall boundaries and openings. Wall boundaries not parallel to the X- or Y-axis may be defined by steps that approximate the sloped boundary.
2. Grid lines must exist along the boundaries of wall thickness changes, wall material property changes, design criteria changes, and stiffener locations.
3. Grid lines must exist along boundaries of area loads.
4. Grid lines must exist along line loads.
5. Grid intersections must exist at locations of point loads and supports.

The above guidelines basically form the major grid lines which produce the minimum number of finite elements for the particular wall geometry. The mesh can be refined by supplementing the model with minor grid lines between the major grid lines. Minor grid lines need to be added to achieve a uniform, well-graded mesh that produces results which effectively capture the variations of the displacements and element forces. The location of the minor grid lines also depends on the level of accuracy that is desired from the analysis.

While the use of finer meshes will generally produce more accurate results, it will also require more solution time, computer memory, and disk space. For wall regions where heavy concentrated forces are applied and anywhere drastic changes in geometry exist, the use of finer element meshes may be required. Thus, in order to obtain a practical as well as an accurate analytical solution, engineering judgment must be used.

The element nodal incidences are internally computed by the program. All nodes and elements are numbered from left to right (in the positive X-direction) and from bottom to top (in the positive Y-direction), as shown in Figure 2-3. When the reference grid system and/or assembling of elements is modified, all node and element numbers are internally modified by the program.

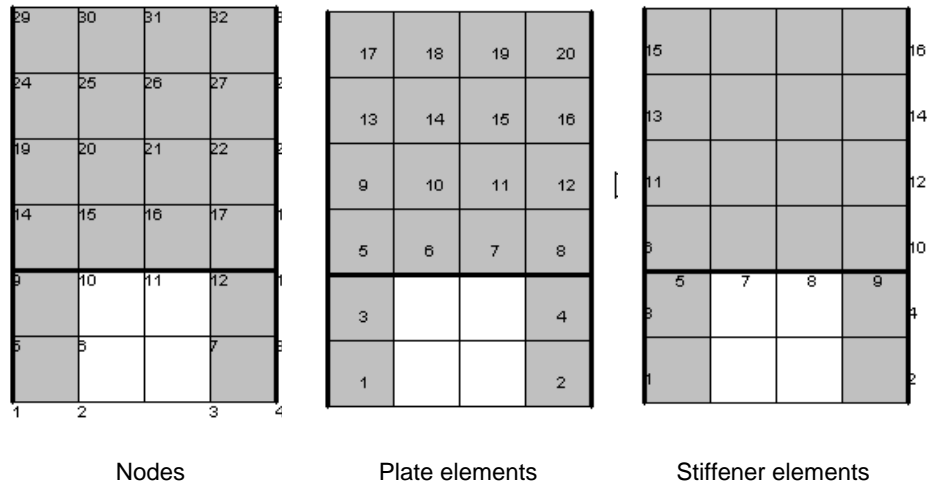

Figure 2-3 Node and Element Numbering

Plate Element

The rectangular plate finite element has four nodes, one at each corner, as shown in Figure 2-4. Each node has six degrees of freedom (D_x , D_y , D_z , R_x , R_y , and R_z). The rotation, R_z , is referred to as the drilling rotation (ref. 1).

The plate element combines the membrane (in plane) and bending (out of plane) actions. Element stiffness is calculated based on the following assumptions:

1. The x-y plane is the mid surface of the plate element.
2. Deformations are small and the resulting displacements do not significantly change the geometry of the wall.
3. The membrane and bending deformations are uncoupled.
4. Bending behavior follows the thin plate theory (Kirchhoff theory).
5. Plane sections initially normal to the mid-surface remain plane and normal to that surface after bending.
6. The stress component normal to the mid-plane is small compared to other stress components and is neglected.
7. The plate element material is homogeneous, elastic, isotropic, and obeys Hooke's law.

If second order analysis is requested, the stiffness terms related to the bending action are modified to include the effect of in-plane internal forces (Ref. 1).

When locating reinforcement within a plate element, the program refers to the left face and right face. The left face of the panel is defined as the face to the left of the plate centerline when looking along the positive X-axis. See Figure 2-4.

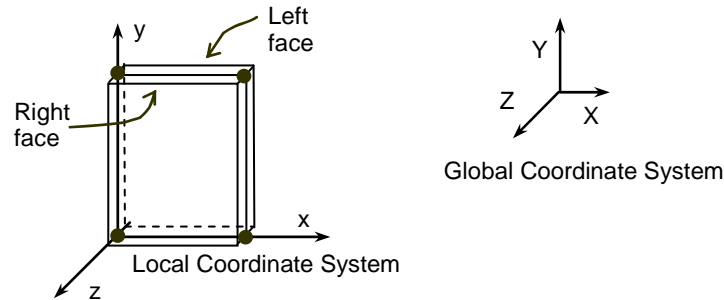

Figure 2-4 Plate Element

Stiffener Element

Stiffener elements can be used to model beams or columns that are embedded in the wall to increase its structural capacity, e.g. lintels, pilasters, and boundary elements of shear walls. Wall piers that are required to be designed as columns can also be modeled using stiffeners. Additionally, isolated stiffener elements placed outside of the wall can model rigid frame structures attached to the wall. The program will calculate internal forces in the stiffener elements and calculate the area of reinforcement required for axial action combined with biaxial bending as well as shear and torsion.

The stiffener element used in the program has two nodes, one at each end, as shown in Figure 2-5. Each node has six degrees of freedom (D_x , D_y , D_z , R_x , R_y , and R_z). Element stiffness is calculated based on the following assumptions:

1. The local x-axis passes through the element centroid.
2. Deformations are small and the resulting displacements do not significantly change the geometry of the wall.
3. Axial and bending deformations are uncoupled.
4. Plane sections initially normal to the element axis remain plane and normal to that axis after bending.
5. The stiffener element material is homogeneous, elastic, isotropic, and obeys Hooke's law.

If second order analysis is requested, the stiffness terms related to the bending about the Y-axis are modified to include the effect of the axial force (Ref. 2).

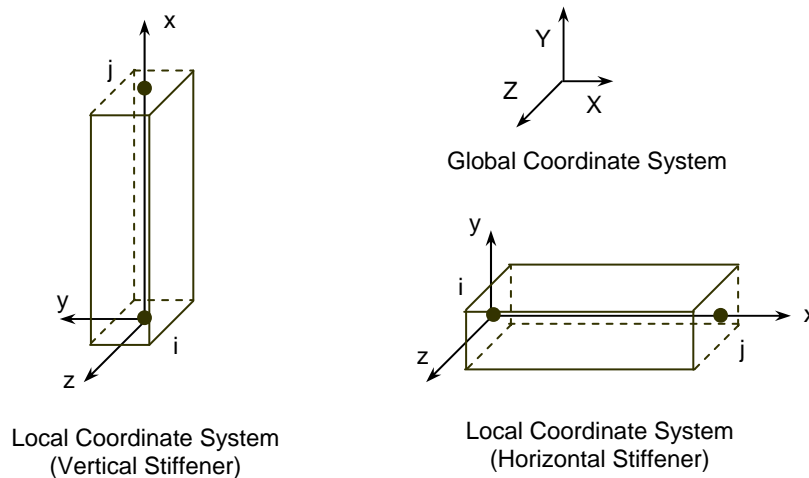

Figure 2-5 Stiffener Element

The properties of the stiffener section, area (A), Inertia (I_y , I_z) and torsional constant (J) are calculated as follows:

$$A = \begin{cases} bh & \text{rectangular section} \\ \pi D^2 & \text{circular section} \end{cases}$$

I_y = Inertia of the web and the flanges about the centroidal local y-axis.

$$I_z = \begin{cases} \frac{hb^3}{12} & \text{rectangular section} \\ \frac{\pi D^4}{64} & \text{circular section} \end{cases}$$

$$J = \frac{w_{fl} t_{fl}^3}{3} + \frac{w_{fr} t_{fr}^3}{3} + \begin{cases} \frac{bh^3}{3} (b > h) & \text{rectangular section} \\ \frac{hb^3}{3} (h > b) & \text{rectangular section} \\ \frac{\pi D^4}{32} & \text{circular section} \end{cases}$$

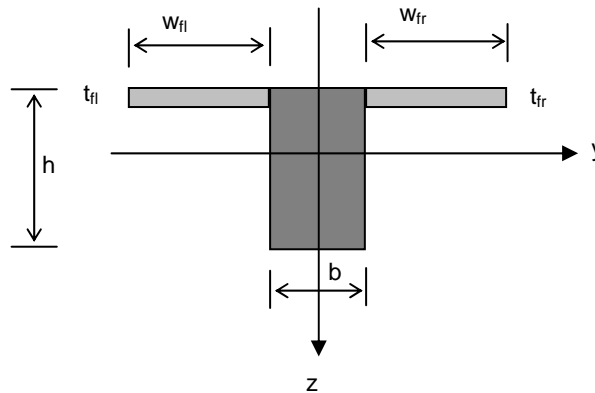

Cracking Coefficients

To account for cracking of elements, the user can input cracking coefficient values for plate and stiffener elements to effectively reduce stiffness. Cracking coefficients for out-of-plane (bending and torsion) and in-plane (axial and shear) stiffness can be entered for plate elements. Cracking coefficients for A , I_z , I_y , and J can be entered for stiffeners. Because the values of the cracking coefficients can have a large effect on the analysis and design results, the user must take care in selecting values that best represent the state of cracking at the particular loading stage. Cracking coefficients are greater than 0 and less than 1.

At ultimate loads, a wall is normally in a highly cracked state. The user could enter a value for out-of-plane cracking coefficient for plates and I_z and I_y cracking coefficients for stiffeners of $I_{cracked}/I_{gross}$ based on estimated values of A_s . With an assumed value of A_s , $I_{cracked}$ can be calculated using the following formula⁴

$$I_{cracked} = \frac{bc^3}{3} + \frac{E_s}{E_c} A_{se} (d - c)^2$$

where $A_{se} = A_s + P_u h / (2df_y)$ for the ACI 318-11/08, $A_{se} = A_s + P_u / f_y$ for the ACI 318-05/02 code, and $A_{se} = A_s$ for the CSA code.

⁴ ACI 318-11, 14.8.3; ACI 318-08, 14.8.3; ACI 318-05, 14.8.3; ACI 318-02, 14.8.3; CSA A23.3-04, 23.3.1.3; CSA A23.3-94, 23.4.1.3

After the analysis and design, if the computed value of A_s greatly differs from the estimated value of A_s , the analysis should be performed again with new values for the crack coefficients⁵.

At service loads, a wall may or may not be in a highly cracked state. For service load deflection analysis, a problem should be modeled with an out-of-plane cracking coefficient for plates, and I_z and I_y cracking coefficients for stiffeners of $I_{\text{effective}}/I_{\text{gross}}$. $I_{\text{effective}}$ is a value between I_{cracked} and I_{gross} . The value of $I_{\text{effective}}$ can be obtained from the following formula⁶

$$I_{\text{effective}} = \left(\frac{M_{\text{cr}}}{M_s} \right)^3 I_{\text{gross}} + \left[1 - \left(\frac{M_{\text{cr}}}{M_s} \right)^3 \right] I_{\text{cracked}} \leq I_{\text{gross}}$$

Types of Loads

An external load is applied as a point load, a line load, or an area load. Positive forces are defined as forces in the positive direction of the global axes, and positive moments are defined in accordance with the right hand rule. In other words, if the thumb of your right hand points in the positive direction of an axis, curling the rest of your right-hand fingers defines the positive moment about that axis.

Point Loads

A point load consists of three forces P_x , P_y , and P_z and three moments M_x , M_y , and M_z corresponding to the six DOF at each node. Point forces have units of force, and point moments have units of force times length. Point forces and point moments must be applied at a node. In addition to point moments, an eccentricity in the Z-direction, E_z , can be input. P_x and P_y values are multiplied by E_z to obtain additional point moments (Figure 2-6). Thus, the final moments at a node are:

$$M_x = \bar{M}_x - E_z P_y \quad \text{and} \quad M_y = \bar{M}_y + E_z P_x,$$

where \bar{M}_x and \bar{M}_y are the moment input by the user about the X and the Y axes respectively.

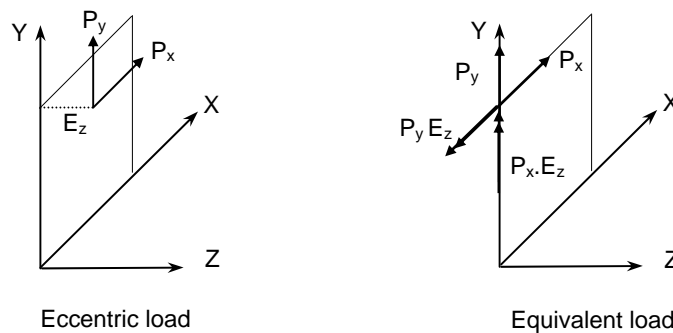

Figure 2-6 Eccentric Point Load

Eccentricity of the load can also account for wall's deviation from plumb that is either measured or assumed based for example on specifications for tolerances⁷.

Line Load

A line load consists of three uniformly distributed line loads W_x , W_y , and W_z corresponding to the three translational DOF at each node and an eccentricity in the Z-direction, E_z . Line loads must be applied along

⁵ For the first approximation of the $I_{\text{cracked}}/I_{\text{gross}}$ ratio the user may also refer to: ACI 318-11, 10.10.4.1; ACI 318-08, 10.10.4.1, ACI 318-05, 10.11.1; ACI 318-02, 10.11.1, CSA A23.3-04, 10.14.1.2; CSA A23.3-94 10.14.1

⁶ ACI 318-11, 9.5.2.3; ACI 318-08, 9.5.2.3; ACI 318-05, 9.5.2.3; ACI 318-02, 9.5.2.3; CSA A23.3-04, 9.8.2.3; CSA A23.3-94, 9.8.2.3

⁷ See deviation from plumb in ACI 117-06, 4.1

the boundary of a plate element or along a stiffener element. W_x , W_y , and W_z have units of force per unit length. Internally in the program, lumped-nodal loads replace the line load as follows (Figure 2-7):

$$\begin{Bmatrix} P_x \\ P_y \\ P_z \end{Bmatrix} = \frac{L}{2} \begin{Bmatrix} W_x \\ W_y \\ W_z \end{Bmatrix}$$

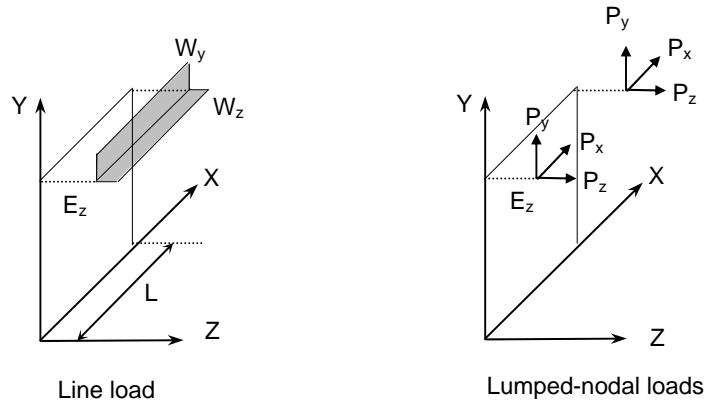

Figure 2-7 Line Load

Uniform Area Loads

A uniform area load consists of three uniformly distributed loads, W_x , W_y and W_z corresponding to the three translational DOF. Area loads are applied over the area of plate elements. W_x , W_y and W_z have units of force per unit area. Internally in the program, lumped-nodal loads replace the uniform area load as follows (Figure 2-8):

$$\begin{Bmatrix} P_x \\ P_y \\ P_z \end{Bmatrix} = \frac{ab}{4} \begin{Bmatrix} W_x \\ W_y \\ W_z \end{Bmatrix}$$

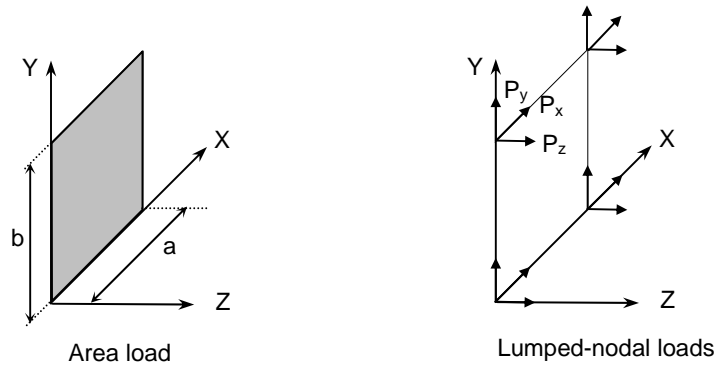

Figure 2-8 Area Load

Linear Area Loads

Linear area loads are used to represent water and earth pressure. The load is defined as linearly varying in the Y direction and uniform in the X direction (Figure 2-9). The load values are defined at two points, along the Y-direction, whose Y-coordinates are denoted Y_1 and Y_2 respectively. The load values are denoted W_{x1} , W_{y1} , and W_{z1} at Y_1 while they are denoted W_{x2} , W_{y2} , and W_{z2} at Y_2 .

The load is applied to an element as uniform area load intensity of which is calculated as follows:

$$\begin{Bmatrix} W_x \\ W_y \\ W_z \end{Bmatrix} = \frac{(Y_2 - Y)}{(Y_2 - Y_1)} \begin{Bmatrix} W_{x1} \\ W_{y1} \\ W_{z1} \end{Bmatrix} + \frac{(Y - Y_1)}{(Y_2 - Y_1)} \begin{Bmatrix} W_{x2} \\ W_{y2} \\ W_{z2} \end{Bmatrix}$$

where Y is the Y-coordinate of the element center.

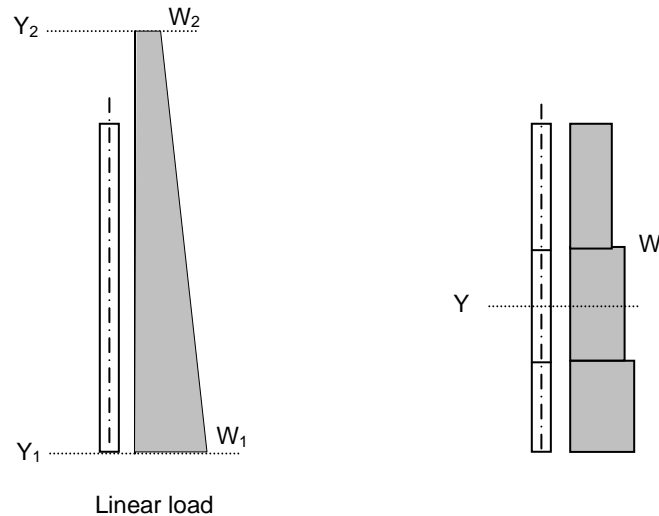

Figure 2-9 Linear Area Load

Self-Weight

The self-weight of the wall is computed internally based on the concrete unit weight and the thickness of each plate element or volume of each stiffener element. For plate elements, the value of self-weight is applied as a uniform area load in the Y-direction. For stiffener element, the value of self-weight is applied as a uniform line load in the Y-direction. The self-weight may optionally be included in the analysis in load case A.

Load Cases and Load Combinations

Applied loads are categorized into six load cases: A, B, C, D, E, and F. Any number of load types can be applied to the wall under each load case. Load cases are combined for load combinations. A load combination is the algebraic sum of each of the load cases multiplied by a load factor. The wall is analyzed and designed for each load combination.

Load combinations are categorized into Service level and Ultimate level. For each Service and Ultimate level combination, the nodal deflections and reactions are calculated. Element internal forces are calculated for each ultimate level combination.

For the design of reinforced concrete elements, the required area of steel is calculated due to the element internal forces belonging to ultimate load combinations. On the other hand, displacement envelopes are determined using the displacement belonging to service load combinations.

Nodal Restraints and Nodal Springs

All nodal degrees-of-freedom (DOF) are assumed to be initially released (i.e. free to move.) Mathematically speaking, each DOF implies an equilibrium equation; however, nodal DOF may be fully restrained against displacement and/or rotation. This allows the definition of wall supports. For equilibrium to exist, the wall must be restrained such that structure stability is achieved.

Nodal DOF can be partially restrained by defining spring supports. Spring constants corresponding to the six DOF can be defined at any node. The spring supports are idealized as linear springs. Units of the spring

constant are in terms of force per unit length for translational springs and moment per radian for rotational springs.

Solution

The solution process is summarized in the following steps:

A. Perform in-plane analysis:

1. Compute the plate and stiffener element matrices related to the in-plane degrees of freedom ($\delta_x, \delta_y, \theta_z$).
2. Assemble the in-plane global stiffness matrix, $[K_i]$.
3. Combine the applied loads and form number of load vectors equal to the number of load combinations, $[F_i]$.
4. Compute the displacement $[U_i]$, by solving the equilibrium equations:

$$[K_i][U_i]=[F_i]$$

This gives the in-plane displacements at each node.
5. Compute the plate element in-plane forces N_{xx} , N_{yy} , and N_{xy} .
6. Compute the stiffener element in-plane end forces F_x , F_y , and M_z .
7. Compute the reaction forces F_x , F_y , and M_z at each restrained node.

B. Perform out-of-plane analysis:

1. If first order analysis is requested, the out-of-plane analysis is done once for all load combinations in a similar way to that done for the in-plane analysis.
2. Out-of-plane analysis gives:
 - i- the displacements ($\delta_z, \theta_x, \theta_y$) at each node,
 - ii- the reaction forces F_z , M_x , and M_y at each restrained node,
 - iii- the plate element internal moments M_{xx} , M_{yy} , M_{xy} ,
 - iv- the stiffener element end forces F_z , M_x , and M_y .
3. If second order analysis is requested (the default setting), a complete analysis cycle is done for each load combination. In each cycle, the basic stiffness terms of plate elements are modified to account for the effect of membrane forces (ref. 1). For stiffener elements, the basic stiffness matrix is modified to account for the effect of axial forces (ref. 2)

C. Compute envelopes for the displacements produced by all service load combinations.

D. For each plate and stiffener element, compute the area of steel required for resisting all ultimate load combinations. For plate elements, the required area of steel is calculated at the element center. For stiffener elements, the area of steel is calculated at each of the element ends. Then, the maximum value of area of steel is reported.

Element Design Forces

Plate Elements

For each ultimate load combination, the program obtains values for in-plane design forces by including the effects of in-plane shear forces as follows:

- Maximum in-plane design forces

$$N_x = N_{xx} + |N_{xy}|$$

$$N_y = N_{yy} + |N_{xy}|$$

$$\text{Maximum } N_{ux} = \begin{cases} N_x & \text{if } N_y \geq 0 \\ N_{xx} + \left| \frac{N_{xy}^2}{N_{yy}} \right| & \text{if } N_y < 0 \end{cases}$$

$$\text{Maximum } N_{uy} = \begin{cases} N_y & \text{if } N_x \geq 0 \\ N_{yy} + \left| \frac{N_{xy}^2}{N_{xx}} \right| & \text{if } N_x < 0 \end{cases}$$

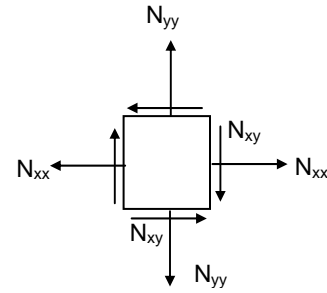

- Minimum in-plane design forces

$$N_x = N_{xx} - |N_{xy}|$$

$$N_y = N_{yy} - |N_{xy}|$$

$$\text{Minimum } N_{ux} = \begin{cases} N_x & \text{if } N_y \leq 0 \\ N_{xx} - \left| \frac{N_{xy}^2}{N_{yy}} \right| & \text{if } N_y > 0 \end{cases}$$

$$\text{Minimum } N_{uy} = \begin{cases} N_y & \text{if } N_x \leq 0 \\ N_{yy} - \left| \frac{N_{xy}^2}{N_{xx}} \right| & \text{if } N_x > 0 \end{cases}$$

In the above equations, N_{xx} , N_{yy} and N_{xy} correspond to the element internal in-plane forces at the element center. The program obtains the values for design bending moments by including the effects of the torsional moment as follows:

- Maximum design bending moments

$$M_x = M_{xx} + |M_{xy}|$$

$$M_y = M_{yy} + |M_{xy}|$$

$$\text{Maximum } M_{ux} = \begin{cases} M_x & \text{if } M_y \geq 0 \\ M_{xx} + \left| \frac{M_{xy}^2}{M_{yy}} \right| & \text{if } M_y < 0 \end{cases}$$

$$\text{Maximum } M_{uy} = \begin{cases} M_y & \text{if } M_x \geq 0 \\ M_{yy} + \left| \frac{M_{xy}^2}{M_{xx}} \right| & \text{if } M_x < 0 \end{cases}$$

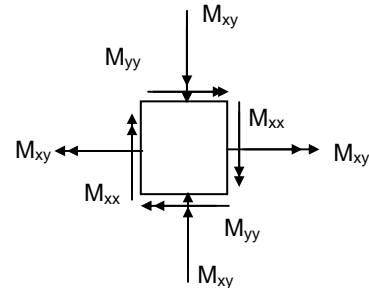

- Minimum design bending moments

$$M_x = M_{xx} - |M_{xy}|$$

$$M_y = M_{yy} - |M_{xy}|$$

$$\text{Minimum } M_{ux} = \begin{cases} M_x & \text{if } M_y \leq 0 \\ M_{xx} - \frac{M_{xy}^2}{M_{yy}} & \text{if } M_y > 0 \end{cases}$$

$$\text{Minimum } M_{uy} = \begin{cases} M_y & \text{if } M_x \leq 0 \\ M_{yy} - \frac{M_{xy}^2}{M_{xx}} & \text{if } M_x > 0 \end{cases}$$

In the above equations, M_{xx} and M_{yy} correspond to the element internal bending moments at the element center, while M_{xy} corresponds to the element internal torsional moment at the element center.

Stiffener Elements

The stiffener element design forces P_u , V_{uy} , V_{uz} , M_{uy} , M_{uz} , and T_u are obtained directly from the element end forces F_x , F_y , F_z , M_x , M_y , and M_z (figure 2-11) using the following relationship:

$$\begin{Bmatrix} N_x \\ V_y \\ V_z \\ T_x \\ BM_y \\ BM_z \end{Bmatrix}_i = \begin{Bmatrix} -F_x \\ F_y \\ F_z \\ M_x \\ M_y \\ -M_z \end{Bmatrix} \text{ at node } i$$

and

$$\begin{Bmatrix} N_x \\ V_y \\ V_z \\ T_x \\ BM_y \\ BM_z \end{Bmatrix}_j = \begin{Bmatrix} F_x \\ -F_y \\ -F_z \\ -M_x \\ -M_y \\ M_z \end{Bmatrix} \text{ at node } j.$$

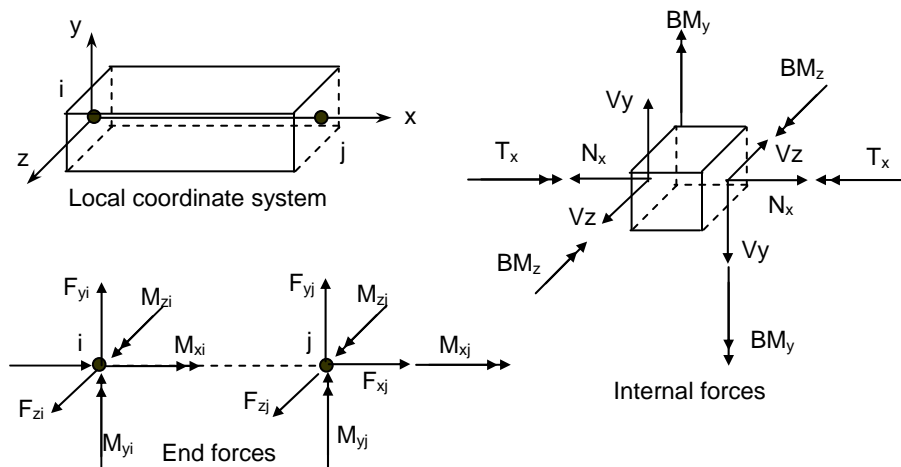

Figure 2-10 Stiffener Internal Forces

Required Reinforcement

The required areas of reinforcing steel for flexural and shear are computed based on assumptions conforming to the strength design method.

Flexural design

Flexural design is performed based on the code provisions of ACI 318 and CSA A23.3 (see Appendix A).

The required area of steel is calculated by trial and error. The program will try to find the least amount of A_s , between the minimum and maximum values specified by the user, which satisfies the strength requirements of all ultimate load combinations. If a value for A_s cannot be found, the program reports design failure.

For plate elements, it is required to calculate the area of steel in the X and in the Y directions. In the X-direction, the area of steel A_{sx} should be enough to satisfy the strength requirements under the following sets of extreme design forces for each ultimate load combinations:

- Maximum N_{ux} and Maximum M_{ux}
- Maximum N_{ux} and Minimum M_{ux}
- Minimum N_{ux} and Maximum M_{ux}
- Minimum N_{ux} and Minimum M_{ux}

In the Y-direction, the amount of steel A_{sy} should be enough to resist the following sets of extreme design forces for each ultimate load combinations:

- Maximum N_{uy} and Maximum M_{uy}
- Maximum N_{uy} and Minimum M_{uy}
- Minimum N_{uy} and Maximum M_{uy}
- Minimum N_{uy} and Minimum M_{uy}

For stiffener element, the area of steel A_s is calculated such that the strength requirements at both end nodes are satisfied for all ultimate load combinations. The design of stiffener elements has two modes: biaxial and uniaxial modes.

The biaxial mode is applied when the flange width is equal to zero (Figure 2.12). In this case, the area of steel is calculated due to P_u , M_{uy} , and M_{uz} . When the flange width is specified, the neutral axis is forced to be along the local y axis. In this case, the area of steel is calculated due to P_u and M_{uy} .

Shear design of stiffener elements

Shear design is performed based on the provisions of ACI 318 and the simplified method of CSA A23.3 (see Appendix A).

For stiffener element, web reinforcement for shear and torsion A_v/s and longitudinal torsion reinforcement (A_l) are calculated such that the strength requirements at both end nodes are satisfied for all ultimate load combinations. The design of stiffener element has two modes: biaxial and uniaxial modes.

The biaxial mode is applied when the flange width is equal to zero. In this case, the amount of web reinforcement A_v/s is calculated in the Y-direction and in the Z-direction separately. The maximum values of $(A_v/s)_y$ and $(A_v/s)_z$ are reported. When the flange width is specified, the neutral axis is forced to be along the local y axis. In this case, the amount of web reinforcement (A_v/s) is calculated in the Z-direction only and the maximum value of $(A_v/s)_z$ is reported. The effective flange width considered for the design due to torsion is calculated according to clause 13.2.4 for ACI 318, clause 13.1 for CSA A23.3-94, and clause 13.8.2.7 for CSA A23.3-04.

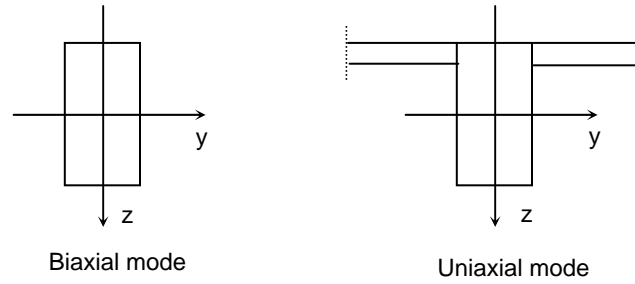

Figure 2-11 Design Modes for Stiffener Elements

Procedure for calculating additional longitudinal reinforcement due to shear and torsion based on CSA A23.3-04 standard.

Proportioning of longitudinal reinforcement for sections subjected to combined shear and torsion in flexural regions is based on the requirement that the resistance of the longitudinal reinforcement has to be greater or equal to the axial force that can be developed in this reinforcement. In non-prestressed sections ($V_p = 0$) these forces are equal to⁸:

- flexural tension side

$$F_{lt} = \underbrace{\frac{M_f}{d_v} + 0.5N_f}_{F_{lt,flexure}} + \cot \theta \underbrace{\sqrt{(V_f - 0.5V_s)^2 + \left(\frac{0.45p_h T_f}{2A_o}\right)^2}}_{F_{lt, shear}} = F_{lt,flexure} + F_{lt, shear}$$

- flexural compression side

$$F_{lc} = -\underbrace{\frac{M_f}{d_v} + 0.5N_f}_{F_{lc,flexure}} + \cot \theta \underbrace{\sqrt{(V_f - 0.5V_s)^2 + \left(\frac{0.45p_h T_f}{2A_o}\right)^2}}_{F_{lc, shear}} = F_{lc,flexure} + F_{lc, shear}$$

These forces can be decomposed⁹ into flexure and shear components. The flexure components, $F_{lt,flexure}$ and $F_{lc,flexure}$, account for the action of the bending moment, M_f , and the axial force, N_f , whereas the shear components, $F_{lt, shear}$ and $F_{lc, shear}$, account for the action of the shear force, V_f , and the torsional moment, T_f . The amounts of reinforcement needed to resist the flexure components are calculated separately in the flexure and axial design procedure. The total amount of the additional longitudinal reinforcement, A_1 , needed to resist shear and torsion will be determined as follows:

$$A_1 = \frac{F_{lt, shear} + F_{lc, shear}}{\phi_s f_y} = \frac{2 \cot \theta \sqrt{(V_f - 0.5V_s)^2 + \left(\frac{0.45p_h T_f}{2A_o}\right)^2}}{\phi_s f_y}$$

Please note that if only torsion acted ($V_f = 0$ and $V_s = 0$), then (assuming¹⁰ $\theta = 35^\circ$) A_1 would reduce to

⁸ CSA A23.3-04, 11.3.9.2, 11.3.9.3, 11.3.10.6

⁹ J.G. MacGregor, F.M. Bartlett, *Reinforced Concrete – Mechanics and Design*, First Canadian Edition, 2000, pp 294, Eq. 7-42

¹⁰ CSA A23.3-04, 11.3.6.3

$$A_1 = 2 \cot 35^\circ \frac{\left(\frac{0.45 p_h T_f}{2A_o} \right)}{\phi_s f_y} = 1.285 \frac{p_h T_f}{2A_o \phi_s f_y}$$

which is comparable (and conservative) to the additional amount of longitudinal reinforcement due to torsion required in accordance with the previous edition of the CSA A23.3 standard¹¹.

The additional longitudinal reinforcement, A_1 , will only be calculated if a section is subjected to a significant shear or a significant torsion¹², which is presumed to be the case¹³ if $V_f > V_c$ or $T_f > 0.25T_{cr}$. Otherwise, it is assumed that the flexural reinforcement is extended a distance of $d_v \cot \theta$ beyond the location needed by flexure alone and the additional reinforcement $A_1 = 0$.

In the biaxial case with two shear forces, V_{fy} and V_{fz} , the total additional reinforcement will be calculated as the sum of amounts needed in each directions i.e.

$$A_1 = A_{1y} + A_{1z}$$

with

$$A_{1z} = \begin{cases} \frac{2 \cot \theta \sqrt{(V_{fz} - 0.5V_{sz})^2 + \left(\frac{0.45 p_h T_f}{2A_o} \right)^2}}{\phi_s f_y} & \text{if } V_{fz} > V_{cz} \text{ or } T_f > 0.25T_{cr} \\ 0 & \text{if } V_{fz} \leq V_{cz} \text{ and } T_f \leq 0.25T_{cr} \end{cases}$$

and

$$A_{1y} = \begin{cases} \frac{2 \cot \theta (V_{fy} - 0.5V_{sy})}{\phi_s f_y} & \text{if } V_{fy} > V_{cy} \\ 0 & \text{if } V_{fy} \leq V_{cy} \end{cases}$$

Wall Shear Strength

The program can calculate in-plane and out-of plane shear strength provided by concrete of the wall horizontal cross-sections at each grid level. The calculated strength is then compared at each section to shear forces calculated from the applied loads. The option to calculate and check wall shear strength can be activated in the solver options only if the wall is solid (i.e. has no openings) and ACI code is selected.

The ACI 318 code provides two sets of provisions to calculate wall shear strength. Detailed provisions are available in the program only for walls with constant thickness and concrete material. These walls are referred to by the program as uniform walls. For non-uniform walls, where wall thickness or concrete material is not constant, only simplified provisions are available. The user can invoke either detailed or simplified provisions for uniform walls based on their engineering judgment.

¹¹ CSA A23.3-94, 11.3.9.5

¹² CSA A23.3-04, 11.3.9.1

¹³ CSA A23.3-04, 11.2.8.1, 11.2.9.1

If wall shear strength is exceeded in the out-of-plane direction then the increase of concrete strength or wall thickness should be considered, or additional transverse reinforcement in the form of ties, stirrups, or headed bars should be provided. The amount of transverse reinforcement has to be calculated by the user separately.

To account for in-plane shear, the program calculates horizontal and vertical reinforcement requirement using formulas described in Element Design Forces section. This reinforcement is calculated for each element using different approach than stipulated by Shear Provisions for Walls in ACI code¹⁴. When the concrete in-plane shear strength is exceeded by calculated shear forces, the increase of concrete strength or wall thickness should be considered. Alternatively, additional horizontal and vertical shear reinforcement should be provided as required by ACI provisions for walls¹⁵. This would be conservative since the contribution of in-plane shear is partially considered in axial and flexural reinforcement design as described in Element Design Forces section

Wall Shear Strength Provided by Concrete – In-plane

Simplified Equations

In-plane shear strength provided by section ‘j’ in a uniform or non-uniform concrete wall is calculated using the following equations¹⁶:

$$V_{cxj} = \begin{cases} 2 \sum_{i=1}^n \lambda \sqrt{f'_{c_{ji}}} h_{z_{ji}} d_{x_j} & \text{if } N_{uyj} > 0, \text{ (compression)} \\ 2 \sum_{i=1}^n \lambda \sqrt{f'_{c_{ji}}} h_{z_{ji}} d_{x_j} & \text{if } N_{uyj} = 0 \\ 2 \left(1 + \frac{N_{uyj}}{500A_{g_j}} \right) \sum_{i=1}^n \lambda \sqrt{f'_{c_{ji}}} h_{z_{ji}} d_{x_j} & \text{if } (-500A_{g_j}) < N_{uyj} < 0, \text{ (tension)} \\ 0 & \text{if } N_{uyj} \leq -500A_{g_j} \end{cases}$$

where:

- j = index of the horizontal cross-sections either above or below a horizontal grid line
- i = summation index of wall elements along the section ‘j’
- n = number of elements along the section ‘j’
- N_{uyj} = global factored axial force equal to the sum of vertical Y-axis components of all forces above the section ‘j’ including applied loads and reactions, positive if compressive and negative if tensile
- λ = factor to account for low-density concrete¹⁷
- ℓ_{w_j} = overall length of the wall along the section ‘j’
- d_{x_j} = $0.8 \ell_{w_j}$
- $h_{z_{ji}}$ = thickness in Z-direction of the wall element ‘i’ along the section ‘j’
- $\sqrt{f'_{c_{ji}}}$ = square root of specified compressive strength of concrete for the wall element “i” along the section ‘j’. The value of $\sqrt{f'_{c_{ji}}}$ shall not exceed 100 psi.
- A_{g_j} = gross area of concrete section ‘j’

¹⁴ ACI 318-11, 11.9; ACI 318-08, 11.9, ACI 318-05, 11.10, ACI 318-02, 11.10

¹⁵

¹⁶ ACI 318-11, 11.9.5, 11.9.4, 11.2.2.3; ACI 318-08, 11.9.5, 11.9.4, 11.2.2.3; ACI 318-05, 11.10.5, 11.10.4, 11.3.2.3; ACI 318-02, 11.10.5, 11.10.4, 11.3.2.3

¹⁷ ACI 318-11, 8.6.1; ACI 318-08, 8.6.1; ACI 318-05, 11.2.1.2; ACI 318-02, 11.2.1.2

Detailed Equations

In-plane shear strength provided by section 'j' in a uniform concrete wall can be based on the following detailed equations¹⁸:

$$V_{cx_j} = \min \left[\begin{array}{l} \left(0.6\lambda\sqrt{f'_{c_j}} + \frac{\ell_{w_j} \left(1.25\lambda\sqrt{f'_{c_j}} + 0.2\frac{N_{uy_j}}{\ell_{w_j}h_{z_j}} \right)}{\frac{M_{uz_j}}{V_{ux_j}} - \frac{\ell_{w_j}}{2}} \right) h_{z_j} d_{x_j} \\ 3.3\lambda\sqrt{f'_{c_j}} h_{z_j} d_{x_j} + \frac{N_{uy_j} d_{x_j}}{4\ell_{w_j}} \end{array} \right]$$

$$\text{If } \frac{M_{uz_j}}{V_{ux_j}} - \frac{\ell_{w_j}}{2} \leq 0 \text{ then } V_{cx_j} = 3.3\lambda\sqrt{f'_{c_j}} h_{z_j} d_{x_j} + \frac{N_{uy_j} d_{x_j}}{4\ell_{w_j}}$$

where

- V_{ux_j} = global factored in-plane shear force equal to the absolute value of sum of horizontal X-axis components of all forces above the section 'j' including applied loads and reactions. V_{ux_j} cannot exceed $10\phi\sqrt{f'_{c_j}} h_{z_j} d_{x_j}$ for ACI 318-11/08 codes¹⁹ and $10\phi\lambda\sqrt{f'_{c_j}} h_{z_j} d_{x_j}$ for ACI 318-05/02 codes²⁰.
- M_{uz_j} = global factored in-plane bending moment equal to the sum of moments about Z-axis with respect to the centroid of the critical section of all forces above the section 'j' including applied loads and reactions
- ℓ_{w_j} = overall length of the wall along the section 'j'
- d_{x_j} = $0.8 \ell_{w_j}$ (ACI 318-08, 11.9.4, ACI 318-05/02, 11.10.4)

Wall Shear Strength Provided by Concrete – Out-of-plane

Simplified Equations

Out-of-plane shear strength provided by section 'j' in a uniform or non-uniform concrete wall is calculated using the following equations²¹

$$V_{cz_j} = \begin{cases} 2 \left(1 + \frac{N_{uy_j}}{2000A_{g_j}} \right) \sum_{i=1}^n \lambda \sqrt{f'_{c_{j_i}}} l_{w_j} d_{z_{j_i}} & \text{if } N_{uy_j} > 0, \text{ (compression)} \\ 2 \sum_{i=1}^n \lambda \sqrt{f'_{c_{j_i}}} l_{w_j} d_{z_{j_i}} & \text{if } N_{uy_j} = 0 \\ 0 & \text{if } N_{uy_j} < 0, \text{ (tension)} \end{cases}$$

where:

¹⁸ ACI 318-11, 11.9.6; ACI 318-08, 11.9.6; ACI 318-05, 11.10.6; ACI 318-02, 11.10.6

¹⁹ 11.9.3, 11.9.4, 11.1.1

²⁰ ACI 318-05, 11.10.3, 11.10.4, 11.2.1, 11.1.1; ACI 318-02, 11.10.3, 11.10.4, 11.2.1, 11.1.1

²¹ ACI 318-11, 11.2.1, 11.2.2.3; ACI 318-08, 11.2.1, 11.2.2.3; ACI 318-05, 11.3.1, 11.3.2.3; ACI 318-02, 11.3.1, 11.3.2.3

- d_{z_i} = distance in Z-direction from extreme compression fiber to centroid of vertical tension reinforcement of the wall element “i” the section ‘j’ (may depend on the sign of M_{u_x} if vertical reinforcement layers are not placed symmetrically)
 ℓ_{w_j} = overall length of the wall along the section ‘j’
 $\sqrt{f'_{c_i}}$ = square root of specified compressive strength of concrete for the wall element “i” along the section ‘j’. The value shall not exceed 100 psi.
 A_{g_j} = gross area of concrete section ‘j’

Detailed Equations

The detailed calculation of in-plane shear strength is allowed by the program for uniform concrete walls based on the following equations²²

$$V_{cz_j} = \begin{cases} \min \left[\begin{aligned} & \left(1.9\lambda\sqrt{f'_{c_j}} + 2500\rho_{w_j} \frac{V_{uz_j} d_{z_j}}{M_{ux_j} - N_{uy_j} \frac{4h_{z_j} - d_{z_j}}{8}} \right) \ell_{w_j} d_{z_j} & \text{if } N_{uy_j} > 0, \text{ (compression)} \\ & 3.5\lambda\sqrt{f'_{c_j}} \ell_{w_j} d_{z_j} \sqrt{1 + \frac{N_{uy_j}}{500A_{g_j}}} & \text{and} \\ & & M_{ux_j} - N_{uy_j} \frac{4h_{z_j} - d_{z_j}}{8} > 0 \end{aligned} \right] \\ 3.5\lambda\sqrt{f'_{c_j}} \ell_{w_j} d_{z_j} \sqrt{1 + \frac{N_{uy_j}}{500A_{g_j}}} & \text{if } N_{uy_j} > 0, \text{ (compression)} \\ & \text{and} \\ & M_{ux_j} - N_{uy_j} \frac{4h_{z_j} - d_{z_j}}{8} \leq 0 \\ \min \left[\begin{aligned} & \left(1.9\lambda\sqrt{f'_{c_j}} + 2500\rho_{w_j} \min \left(\frac{V_{uz_j} d_{z_j}}{M_{ux_j}}, 1.0 \right) \right) \ell_{w_j} d_{z_j} & \text{if } N_{uy_j} = 0 \\ & 3.5\lambda\sqrt{f'_{c_j}} \ell_{w_j} d_{z_j} \end{aligned} \right] \\ 2\lambda\sqrt{f'_{c_j}} \ell_{w_j} d_{z_j} \left(1 + \frac{N_{uy_j}}{500A_{g_j}} \right) & \text{if } (-500A_{g_j}) < N_{uy_j} < 0, \text{ (tension)} \\ 0 & \text{if } N_{uy_j} \leq -500A_{g_j} \end{cases}$$

where

- d_{z_j} = distance (in Z-axis direction) from extreme compression fiber to centroid of vertical tension reinforcement (may depend on the sign of M_{u_x} if vertical reinforcement layers are not placed symmetrically) along the section ‘j’ (above and below the horizontal grid line)
 h_{z_j} = thickness of the wall in Z-direction along the section ‘j’
 ρ_{w_j} = vertical tension reinforcement ratio along the section ‘j’ conservatively assumed by the program to be equal to the minimum vertical reinforcement ratio²³ of 0.0012

²² ACI 318-11, 11.2.2, 11.2.2.3; ACI 318-08, 11.2.2, 11.2.2.3; ACI 318-05, 11.3.2, 11.3.2.3; ACI 318-02, 11.3.2, 11.3.2.3

²³ ACI 318-11, 14.3.2; ACI 318-08, 14.3.2; ACI 318-05, 14.3.2; ACI 318-02, 14.3.2

Program Results

The program output is organized into tables that may be optionally viewed, printed, or sent to file. Furthermore, the tables may be fully or partially output for all or for only selected nodes, members, and load combinations.

Nodal Displacements:

Nodal displacements D_x , D_y , and D_z are output for individual service and individual ultimate load combinations. Positive displacement is in the positive direction of the axes. If the user selects the option to check out-of-plane displacement against the maximum permissible value provided by the user, the program will perform the comparison and flag service displacement results where the permissible values are exceeded.

Reactions:

Restraint and Nodal Spring reactions are output for individual service load and ultimate load combinations for nodes with specified restraints or nodal springs. Nodal translational reactions F_x , F_y , and F_z , and rotational reactions M_x , M_y , and M_z are output. Positive translational reactions are in the direction of the positive axes and positive moment reactions are determined using the right-hand rule. The program also reports sum of forces and moments (with respect to wall center of gravity) for applied loads and reactions.

Element Internal forces:

For each plate element, internal forces N_{xx} , N_{yy} , N_{xy} , M_{xx} , M_{yy} and M_{xy} are output for individual service or ultimate load combination.

For each stiffener element, internal forces N , V_y , V_z , BM_y , BM_z and T_x are output for individual service or ultimate load combination.

Displacement Envelopes:

Maximum nodal displacements D_x , D_y , and D_z from all service load combinations are output. The governing load combination is identified. Positive displacements are in the direction of the positive axes.

Element Reinforcement:

For each plate element, the required areas of reinforcement A_{sx} and A_{sy} are computed based on the average moments per element and are output along with design forces and governing ultimate load combination. In both horizontal and vertical directions, the reported reinforcement is the total required area of steel per unit length. Half of the reported value applies to each curtain in models with two curtain layout.

If the area of vertical reinforcement for a plate element is greater than one percent (0.5 percent for CSA A23.3-04), the program indicates that ties are required for bars in compression. If the program reports that ties are required for a single curtain design, switching to two curtain design should be considered by the user.

For each stiffener element, the required area of longitudinal reinforcement for flexure and axial loads A_s , transverse reinforcement, A_v/s , required for shear and torsion, and torsional transverse reinforcement A_t/s and A_l are output along with the design forces and governing ultimate load combination. Area of transverse reinforcement required for shear only can be calculating by subtracting twice the torsional reinforcement area from the area required for both shear and torsion.

Wall Cross-sectional Forces

The program reports values of cross-sectional forces (N_{uy} , V_{ux} , V_{uz} , M_{ux} , M_{uy} , M_{uz}) at entire wall sections directly above (+) and directly below (–) each horizontal grid line level. The cross-sectional forces are calculated as sums of all corresponding forces or moments (with respect to cross-section centroid) applied as loads or reactions on one side of the section less forces and moments transferred by stiffeners if the wall section intersects any.

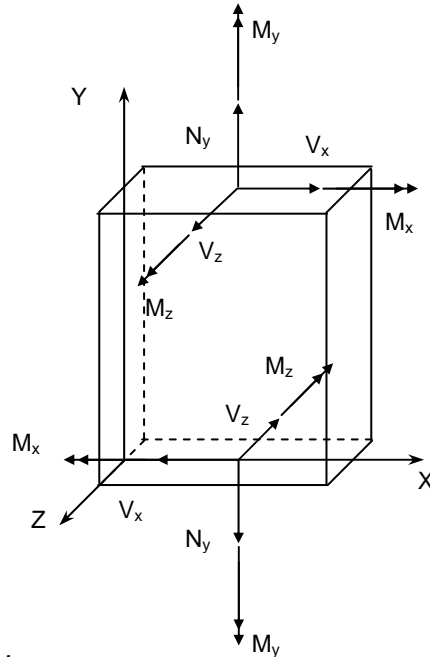

Figure 2-12 Wall Cross-sectional Forces

The wall cross-sectional forces are used by the program to determine wall shear strength provided by concrete. The user may also use these forces to verify correctness of load input or as input to supplemental calculations of flexural and shear reinforcement for entire wall cross-sections.

Wall Shear Strength

For solid (without openings) walls designed according to the ACI code, the program optionally reports factored in-plane (ϕV_{cx}) and out-of-plane (ϕV_{cz}) shear strength provided by concrete in entire wall cross-sections above and below each horizontal grid line level. The shear strengths are also compared to the corresponding calculated shear forces V_{ux} and V_{uz} , respectively. The comparison may be used by the user to determine the adequacy of the wall thickness and whether additional shear reinforcement or minimum shear reinforcement is required in addition to the axial and flexural reinforcement calculated by the program.

References

- [1] Cook, Robert D., Malkus, David S., and Plesha, Michael E., *Concepts and Applications of Finite Element Analysis*, John Wiley & Sons, Third Edition, 1989.
- [2] Ghali, A.M. Neville, *Structural Analysis, a Unified Classical and Matrix Approach*, John Wiley & Sons, Fifth Edition, 2003.
- [3] ACI 318-02, *Building Code Requirements for Structural Concrete*, American Concrete Institute, 2002.
- [4] CSA A23.3-94, *Design of Concrete Structures*, Canadian Standards Association, 1994.
- [5] ACI 318-05, *Building Code Requirements for Structural Concrete*, American Concrete Institute, 2005.
- [6] ACI 318-08, *Building Code Requirements for Structural Concrete*, American Concrete Institute, 2008.
- [7] ACI 318-11, *Building Code Requirements for Structural Concrete*, American Concrete Institute, 2011.
- [8] CSA A23.3-04, *Design of Concrete Structures*, Canadian Standards Association, 2004.

The spWall interface is made up of the elements as illustrated below. The content of the interface's *Main Window* changes depending on what you select from any menu displayed on the *Menu Bar* or from any button displayed in the *Tool Bar*. The *Main Window* is shown in the illustration below...

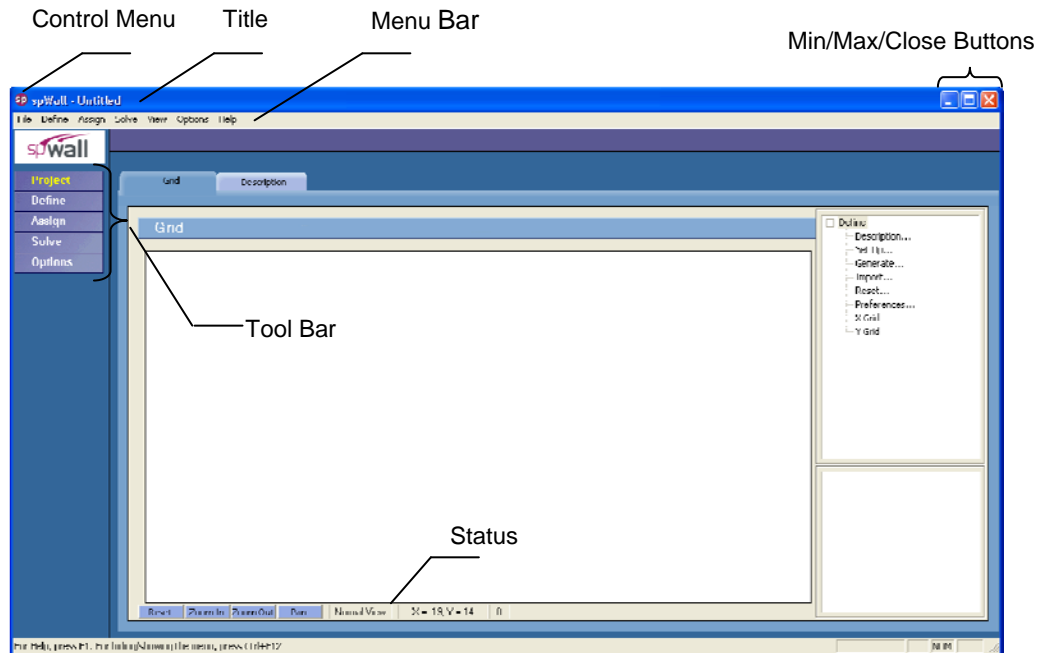

Control Menu:

The *Control-Menu* is located in the upper-left corner of the screen. It includes commands for restoring, moving, sizing, minimizing, maximizing, and closing the program.

Title Bar:

The *Title Bar* displays the name of the program (spWall in this case), along with the path and filename of the current data file in use. If the file is new and has not yet been saved, the word *Untitled* is displayed in the title bar.

Min/Max/Close Buttons:

The *Min/Max/Close* buttons are located in the upper-right corner of the screen. The *Minimize* button (☐) shrinks the program to the Windows Taskbar. The *Maximize* button (☐) enlarges the program so that it covers the entire desktop. After the program has been maximized (takes up the entire screen), the *Maximize* button (☐) is replaced by the *Restore* button (☐). Clicking on the *Restore* button returns the program to its original size.

Tool Bar:

The *Tool bar* is located on the left side of the screen. There are a total of 5 buttons on the tool bar each one displays various information in the *Main Window* of the program. The *Tool Bar* provides access to commands that are also accessible via the *Menu Bar*. The active tool bar's text will appear in Yellow (highlighted).

Menu Bar:

The *Menu Bar* is located directly beneath the *Title Bar*. There are a total of 7 distinct drop-down menus accessible from the *Menu Bar*. The majority of commands appearing in the drop-down menus are also accessible via the program's *Main Window* area.

Status Bar:

The *Status Bar* is located directly beneath the program's *Main Window* area. It displays important information such as current units, cursor position, and helpful messages.

The *Main Window* is made of 4 distinct areas as illustrated here.

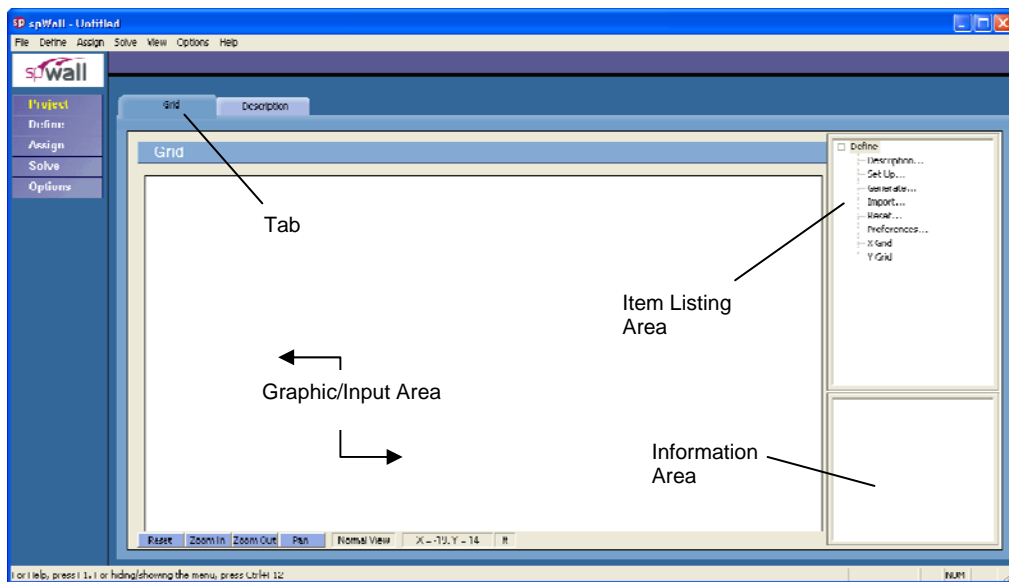

Tabs:

The *Tabs* are located on the *Main Window* and vary depending on the button you click on the TOOL BAR or on the command that you select from one of the drop-down menus. Each *Tab* surfaces different GRAPHICS/INPUT AREAS for recording and inputting data as it relates to each project.

Graphics/Input Area:

The *Graphics/Input Area* covers most of the *Main Window*. This is where the graphical editing and data input is done.

Item Listing Area:

The *Item Listing Area* appears on the right side of the *Main Window*. The items appearing in the listing vary depending on the *Tab* that you select. Certain items appearing in listings have “plus” or “minus” signs indicating that the list is expandable or retractable, respectively.

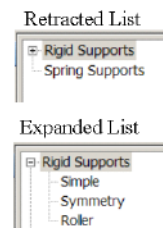

Information Area:

The *Information Area* appears in the lower-right corner of the *Main Window*. This area displays helpful information and values pertinent to the active item that you select in the *Item Listing Area*.

File Menu

The **File** menu gives access to file operations, printing operations and to exiting the spWall program.

New (Ctrl+N)

Clears any input data and returns the data to the default values so that a new data file may be input.

Open (Ctrl+O)

Opens an existing data file.

Save (Ctrl+S)

Saves the changes made to the current data file to disk.

Save As

Enables you to name or rename a data file.

Revert

Discards any changes to the data file and returns to the most recently saved version of the data file. This option will only be available if the data file has been previously saved and there have been modifications done on the data file since. Do not save the data file immediately prior to reverting otherwise this command will have no effect.

Print Results (Ctrl+P)

Provides a printout of the input and output data.

Print Preview

Displays how the graphical image will appear on the page if the Print Screen option is selected.

Print Screen

Prints the graphical image displayed in the GRAPHICS/INPUT AREA of the MAIN WINDOW.

Import / Grids

Imports grid definition from an ASCII (TXT) file.

Import / Loads

Imports load definitions from an ASCII (TXT) file.

Import/ Load Combinations

Imports load combination definitions from an ASCII (TXT) file.

Export / Wall Elevation to DXF File

Exports wall elevation view to a DXF file for easier integration with drafting and modeling software.

New	Ctrl+N
Open...	Ctrl+O
Save	Ctrl+S
Save As...	
Revert	
Print Results	
Print Preview	
Print Screen	Ctrl+P
Import	▶
Export	▶
1 Example1.wa4	
2 Example2.wa4	
Exit	

Exit

Ends the spWall program.

Define Menu

The **Define** menu provides access to commands used to define all of the input data. The information you input via the commands found under the Define menu will be used when assigning, and for calculating and designing the wall.

Project Description

Defines and records the particulars on the project including project name and description, project date and time, and engineering parameters including units of measure and design code.



Grid

Defines the grid lines that make up the rectangular grid system. The wall model is defined based on the grid system specified here. This command also gives access to the grid preferences where you are able to show/hide node and element numbers, select between dotted or solid grid lines, and specify the coordinate precision.

Properties

- Plate thickness
Defines the plate element thickness entries.
- Stiffener section
Defines the stiffener element section properties including section type (rectangular, circular), section projection, (to the left, at the middle, to the right), section dimensions and flange dimensions.
- Plate cracking coefficients
Defines the cracking coefficients that reduce the plate element stiffness during the finite element analysis.
- Stiffener cracking coefficients
Defines the cracking coefficients that reduce the stiffener element stiffness during the finite element analysis.
- Concrete
Defines the concrete material properties including compressive strength, unit weight, Young's modulus, Poisson's ratio, and whether concrete is precast or not (i.e. cast-in-place).
- Reinforcement
Defines reinforcing steel material properties including yield strength and Young's modulus.
- Plate design criteria
Defines the parameters that set the criteria for designing the plate element. These parameters include minimum reinforcement ratio, reinforcement layout, and reinforcement location.
- Stiffener design criteria
Defines the parameters that set the criteria for designing the stiffener element. These parameters include minimum reinforcement ratio and reinforcement layout.

Supports

- Rigid supports

Defines rigid support properties including the restraint condition in the direction of each degree of freedom.

- Spring supports

Defines rigid support properties including the value of stiffness in the direction of each degree of freedom.

Loads

- Point loads

Defines point load properties including the value of component in the direction of each degree of freedom as well as the eccentricity away from the wall plane.

- Uniform area loads

Defines uniform area load properties including the value of component in the direction of each translational degree of freedom.

- Linear area loads

Defines linear area load properties including the value of component in the direction of each translational degree of freedom. The load values are defined at two levels of Y-coordinates (Y1 and Y2).

- Uniform line loads

Defines uniform line load properties including the value of component in the direction of each translational degree of freedom as well as the eccentricity away from the wall plane.

Load Combinations

Defines load combinations for both service and ultimate levels under which the model is to be analyzed and designed.

Assign Menu

The Assign menu provides access to commands used to input the model geometry and assign the defined properties and loads to the nodes and elements. All assignments are done graphically.

Properties... Supports... Loads...
--

Properties

- Plate thickness

Assign the various plate thickness definitions in order to grid spaces to define plate elements.

- Plate cracking coefficients

Assign the various cracking coefficient definitions to plate elements.

- Plate concrete

Assign the various concrete definitions to plate elements.

- Plate reinforcement

Assign the various reinforcement definitions to plate elements.

- Plate design criteria

Assign the various plate design criteria definitions to plate elements.

- Stiffener section

Assign the various stiffener section definitions in order to grid to define stiffener elements.

- Stiffener cracking coefficients

Assign the various cracking coefficient definitions to stiffener elements.

- Stiffener concrete
Assign the various concrete definitions to stiffener elements.
- Stiffener reinforcement
Assign the various reinforcement definitions to stiffener elements.
- Stiffener design criteria
Assign the various stiffener design criteria definitions to stiffener elements.

Supports

Assigns the various rigid and spring support definitions to nodes.

Loads

- Point loads
Assigns the various point load definitions to nodes.
- Uniform area loads
Assigns the various Uniform area definitions to plate elements.
- Linear area loads
Assigns the various linear area load definitions to plate elements.
- Uniform line loads
Assigns the various uniform line load definitions to stiffener elements or to the edges of plate elements.

Solve Menu

The Solve menu provides access to commands used to execute the analysis and design.

Execute (F5)

Invokes the finite element solver and then invokes the concrete design module.

Execute...	F5
View Results...	F6
View Wall Contours...	Shift+F6
View Forces Diagrams...	Alt+F6

View Results (F6)

Provide access to the analysis and design results in tabular forms.

View Wall Contours (Shift+F6)

Provides access to graphical representations of the results referring to plate elements.

View Forces Diagram (Alt+F6)

Provides access to graphical representations of the results referring to stiffener elements and to wall cross-sectional forces and shear strength.

View Menu

The View menu provides access to commands used to manipulate the Graphical display and to control what is to be displayed in the GRAPHICS AREA.

Status Bar

Toggles the Status Bar at the bottom of the screen on or off.

<input checked="" type="checkbox"/> Status Bar This Menu Ctrl+F12
Reset Zoom In Zoom Out Pan

This Menu (Ctrl+F12)

Toggles the Menu Bar at the top of the screen on or off.

Reset

Resets the graphical window to the default view.

Zoom-in

Sets the graphical window in the zoom-in mode.

Zoom-out

Sets the graphical window in the zoom-out mode.

Pan

Sets the graphical window in the pan mode.

Options Menu

The Options menu provides access to commands used to save certain settings as defaults for subsequent new projects.

Startup Defaults...
Autosave...
Display Preferences...

Startup defaults

Provides access to saving defaults such as units of measurement and design code so that the system knows to use these for any future data file creations. Controls options for default definitions loaded from templates and default assignment options.

Autosave

Provides access to specify that the system automatically save data periodically without you having to necessarily select the **File/Save** command.

Display preferences

Provides access to turning on and off the display of node and element numbers, choosing the color settings of the graphical display area, font selection, how labels are displayed, setting the grid line width, and specifying the precision of coordinates displayed in the graphics window.

Help Menu

The Help menu includes commands that enable you to obtain online help for the program, check for updates, and show the copyright and registration information about your software.

Help Topics (F1)

Provides access to all available help topics. Click on any topic and a help screen will appear with information about that item.

spWall Help...	F1
spWall Manual...	
Check for Updates...	
About spWall...	

Manual

Opens spWall Manual in the default PDF viewer.

Check for Updates

Checks if a newer version of spWall is available. Internet connection is required.

About spWall

Displays a message box showing the copyright information, the licensing information, and the version number of spWall.

Right Mouse Button Options

The following options are available when right clicking anywhere in the Graphics/Input Area that is not occupied by an element. These options can also be found in the Display tab in Display Preferences menu.

Reset view	
Copy to clipboard	Ctrl+C
Show node labels as	▶
Show node labels for	▶
Show element labels for	▶
Show load values for	▶
Show load labels only	
<input checked="" type="checkbox"/> Show loads using vector format	

Reset View

Resets the graphical window to the default view. Zooming and Translating while Assigning.

Copy to clipboard (Ctrl+C)

Saves the current graphical display of the model to the clipboard so it can be inserted into other programs.

Show node label as.

Provides the option to choose between displaying the node labels as either numbers or coordinates.

Show node labels for

Allows displaying All Nodes, Wall Nodes, Stiffener Nodes, Loaded Nodes, Restrained Nodes, or any combination of these five. To hide all node labels unselect all five options.

Show element labels for

Allows displaying element labels as a number for wall elements, stiffener elements, or both.

Show load values for

Allows displaying load labels Point Loads, Uniform Area Loads, Linear Area Loads, Uniform Line Loads, or any combination of these four. To see load labels the Assign Load tab must be current and the load type must be selected Item Listing Area. All loads are shown using the global coordinate system.

Show load labels only

This option reduces the display of values implemented by the Show Load Values For option to just the load label.

Show loads using vector format

This option changes the load values displayed by the Show Load Values For option from the global coordinate format to a vector format.

In this chapter, the sections are organized in the order in which commands and options appear under the subsequent menu items. We begin with commands found under the **File** menu and end with those under the **Help** menu.

Where the commands and options that appear under these menus are alternatively accessible by other methods, these other methods are also explained.

Creating New Data File

When spWall is first loaded, it is ready to begin receiving input for a new project. Unless you save the file, the data will not have a filename associated with it, and the title bar will display the word *Untitled* as illustrated here...

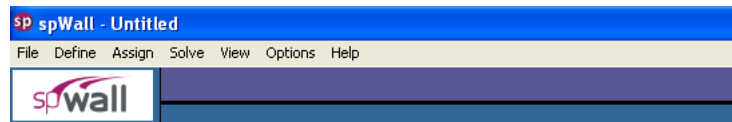

- From the **File** menu, choose **New**. This clears the screen in preparation for a new project or data entry file and returns the program to its default settings.
- If existing data on an open project has been changed prior to executing the **New** command, the program will display the following message box inquiring whether you wish to save the data on the open project or data file before creating a new file...

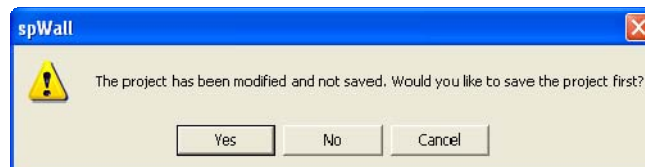

Opening Existing Data File

From the **File** menu, choose **Open** to have the program display the following dialog box...

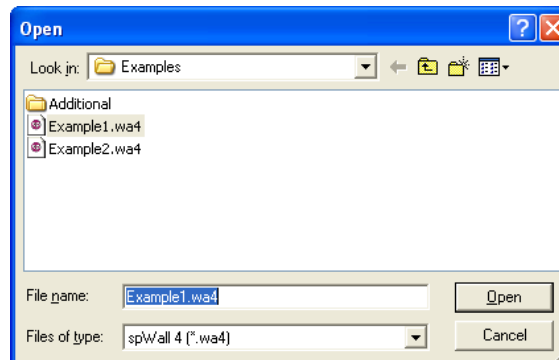

All files with WA4 extensions contained in the current drive and directory are displayed in the listing.

To open a WA4 file that exists in another drive or directory, use the LOOK IN drop-down list and locate the folder where the file exists. Once you locate the folder, the file will appear in the listing. From the white

listing area, either select the file that is to be opened and click on the OPEN button, or simply double-click on the respective file. Alternatively, an input file can be opened by spWall if the file is drag-and-dropped onto the program window or if the file pathname is provided as a command line parameter when invoking spWall from the command prompt.

You can also open data files with WA3 and WAL extensions that were created by previous versions of the program. Use FILES OF TYPE drop-down list to change the type of data files displayed in the OPEN dialog box and browse to the file you want to open.

The data files which were imported from previous versions can be saved under new file format with extension WA4.

Saving Data

spWall files are saved in binary format with WA4 extensions. When information in a data file is modified and until the file is saved, the Title bar will display the word (*Modified*) as illustrated here...

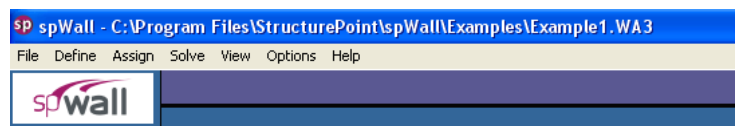

To save your data with the same filename:

- If you are editing an already existing data file and that file has previously been saved (i.e. the TITLE BAR displays a filename), then from the **File** menu, choose the **Save** command. The changes will be recorded under the same filename and the old data file will be overwritten.

To save your data for the first time or to give an existing data file a new filename:

- If you are saving a new data file for the first time (i.e. the TITLE BAR displays *Untitled*), then when you choose **Save** or **Save As** from the **File** menu, the following SAVE AS dialog box will appear...

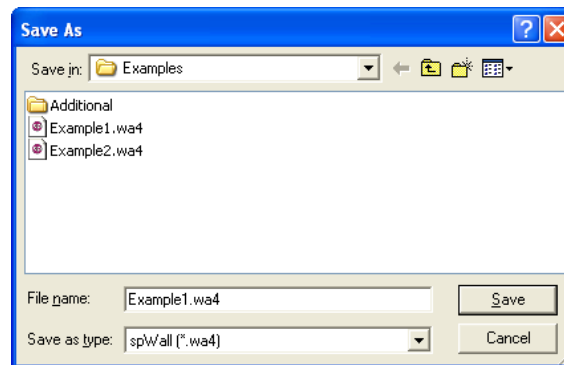

- Similarly, If you are editing an already existing data file and that file has previously been saved (i.e. the TITLE BAR displays a filename), and you wish to record the changes under a different filename, then choose **Save As** to have the program surface the SAVE AS dialog box.
- Use the SAVE IN drop-down list and locate the folder where the file is to be saved. Once you locate the folder, the white listing area will display any other spWall files that have been saved in that folder. Double-click in the FILE NAME text box and type a filename. (You need not enter an extension since, by default, the program will affix the WA4 extension to the filename.) Choose the SAVE button to finish recording the data file.

Reverting to Last Saved Data File

- If you have begun to make changes to a data file that has previously been saved, (i.e. the TITLE BAR displays a filename), and you suddenly wish to discard all the changes and revert back to the previously saved data file, then from the File menu, select Revert.
- The program will verify your intention with the following message box...
- Click on YES only if you are certain that you wish to discard all changes since the last time the file was saved. If you are not sure, another option would be to actually save the file under a different name, and then re-open the old data file.



Note: If **Autosave** option is enabled the program will revert to the data previously saved by the **Autosave** function.

Printing Results

- From the File menu, choose Print Results to have the program surface the REPORTS folder as illustrated here...

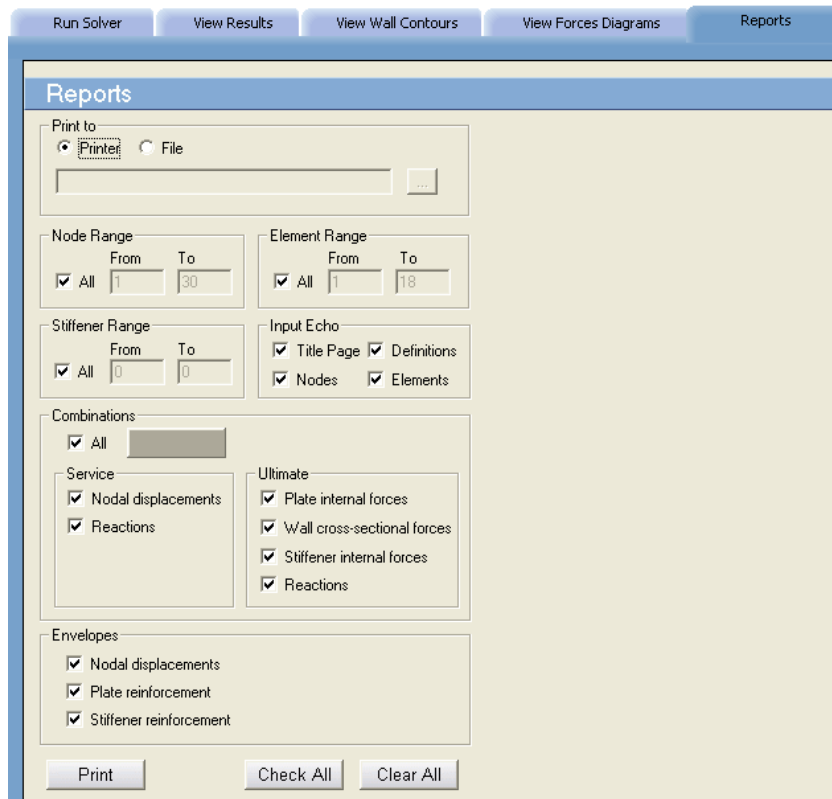

Alternatively, you could have clicked on the **Results** button located on the toolbar, and then on the REPORTS tab.

- Place a checkmark in the TITLE PAGE check box if you wish to include a title page with the printout.
- From the Input Echo group, you may select the tables to be printed.
 - DEFINITIONS: Will print all the input data entered using the **Define** menu commands.
 - NODES: Will list all nodal data including coordinates, assignments, and loads.
 - ELEMENTS: Will print all element indexes, assignments, and loads.
- Select the results to be printed. For more information about the output tables, see Program Results in Chapter 2.

- In the Service group, select which results to be printed for the selected service load combinations.
- In the ULTIMATE group, select which results to be printed for the selected ultimate load combinations.
- In the NODE RANGE, ELEMENT RANGE and STIFFENER RANGE groups, select the ALL check box for a comprehensive output. For selective printing, specify the range of nodes and/or elements to print for.
- In the COMBINATIONS group, select ALL to print for all service and ultimate load combinations. To print for specific combinations, choose the SELECT button to have the program surface the following dialog box...

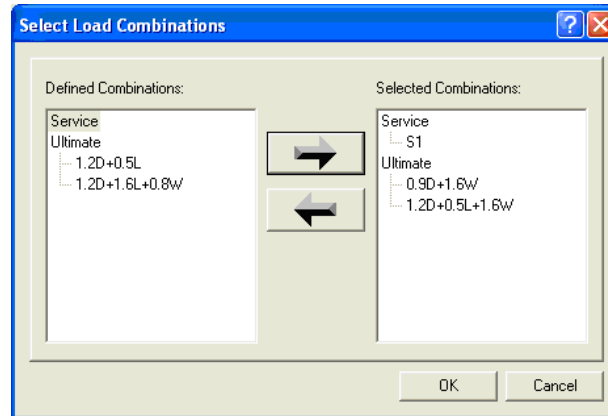

- Highlight the combinations from the Defined Combinations list, and click on the button to move them to the Selected Combinations list. Repeat for all load combinations you wish to select under both Service and Ultimate. To remove a selected combination, highlight the combination from the Selected Combinations list and click on the button. Click on the OK button when done.
- Choose the Envelopes that are to be included in the output (printout).
- Alternatively, CHECK ALL button can be used to include all items in the printout. Clicking on the Clear All button will clear all selected items.
- In the Print To group, specify whether the output should be sent to the default printer or if it should be saved to a file. If FILE is selected, click on the button to specify what it should be named and where it should be saved.
- Click on the PRINT button.

Printing the Screen

- From the **File** menu, choose **Print Screen** to have the program surface the standard Windows print dialog box similar to the following....

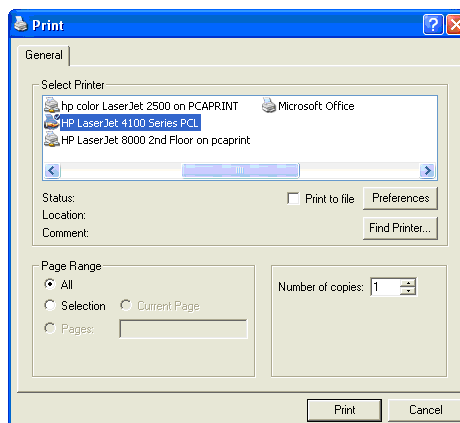

- This command will print the GRAPHICS AREA in a WYSIWYG format. In order for this command to be effective, the current window has to contain a graphical image...

Exporting Wall Elevation to DXF File

The model geometry created in spWall can be exported to CAD programs using the **File/Export/Wall Elevation to DXF File** command. You may have to scale or zoom the drawing in the CAD program to view it at a suitable scale.

- From the **File** menu, select **Export/Wall Elevation to DXF File**. The dialog box of appears.

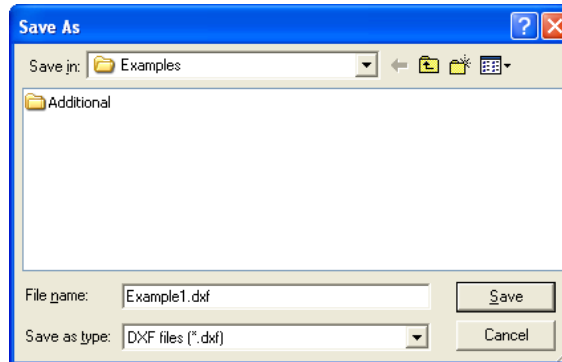

- Use the SAVE IN drop-down list and locate the folder where the file is to be saved. Once you locate the folder, the white listing area will display any other DXF files that have been saved in that folder. If you want to use file name other than the default (same as input file name), double-click in the FILE NAME text box and type a filename. (You need not enter an extension since, by default, the program will affix the DXF extension to the filename.)
- Choose the SAVE button to finish exporting.

Exiting the Program

From the **File** menu, choose **Exit**. If the data file has been modified since the last time it was saved, i.e. the word (*Modified*) appears in the TITLE BAR, then the program will display the following message box...

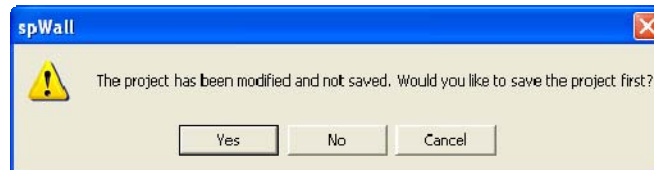

Click on YES to save. NO will exit without saving, and CANCEL will ignore the **Exit** command and return you to the data file.

Defining Project Description

- From the Define menu, choose Project Description to have the program surface the DESCRIPTION folder as illustrated here...
Alternatively, you could have clicked on the **Project** button located on the toolbar, and then on the DESCRIPTION tab.
- Enter the Project Name and any details/notes describing the project (Project Description). The Project Date And Time will default to the instance you started the project however you are free to change it. These fields help organize and identify data sets.
- From the Units options group, choose the applicable units of measure and from the Code options group, select the appropriate design code.

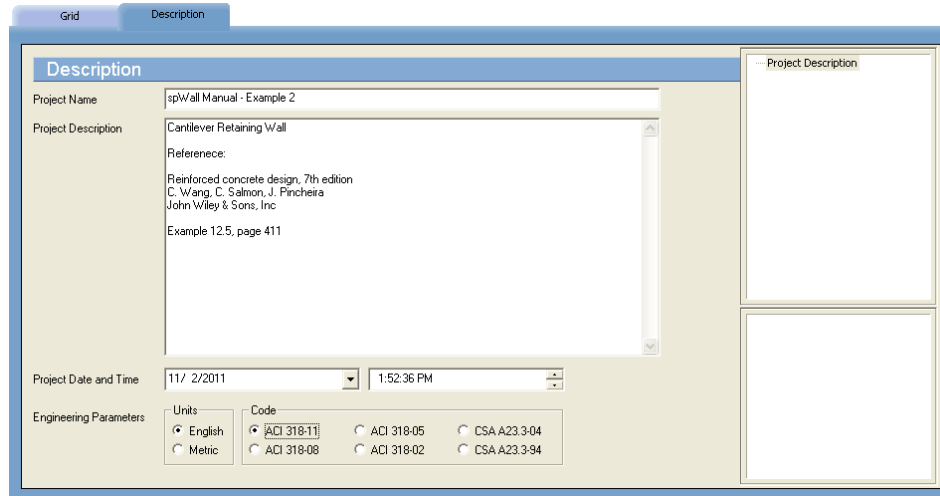

Defining Grid

- The rectangular grid system is defined by inputting the coordinates of the X and Y grid lines. Note that it is possible to generate multiple, equally spaced grid lines as well as individual ones at any location. From the **Define** menu, choose **Grid** to have the program surface the GRID folder as illustrated here...

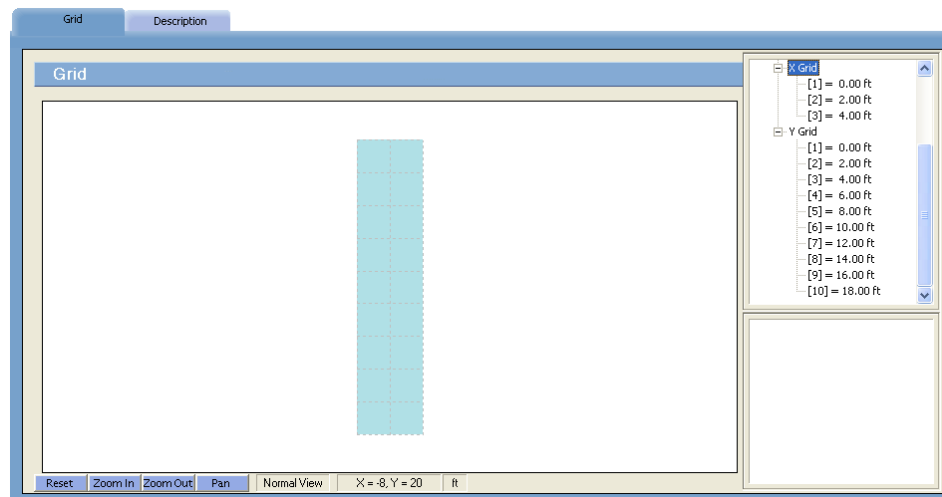

- Alternatively, you could have clicked on the **Project** button located on the toolbar, and then on **the GRID** tab.
- If you wish, you can enter a name and description for the grid. To do this, double-click on DESCRIPTION... found in the right ITEM LISTING AREA. The program will surface the following dialog box...
- Enter a Name and Description or note and Click on OK.

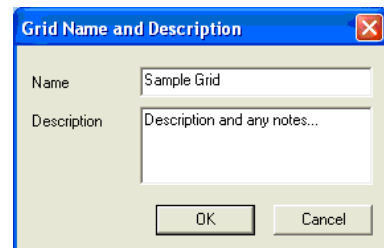

To Enter Grid Lines Individually:

- Double-click on SET UP... found in the right ITEM LISTING AREA to have the program surface the following...
- Select the grid direction from the respective option group, X-Direction or Y-Direction. Grids in the X-Direction are perpendicular to the X-axis and those in the Y-Direction are perpendicular to the Y-axis.

- Enter a grid line coordinate. This value, in feet or meters, represents the orthogonal distance from the origin to the grid line.
- Choose the Add button to add the grid coordinate to the listing area.
- Repeat the two steps above for each grid line.
- If you wish to enter grids separately and individually in the other direction then repeat the above four steps. If you wish to copy the grid lines, you can input them in one direction and then press the Copy button to mirror them in the other direction. For example, if you just finished defining grid lines in the X-Direction then the COPY button will copy all X-grid lines to Y-Direction.

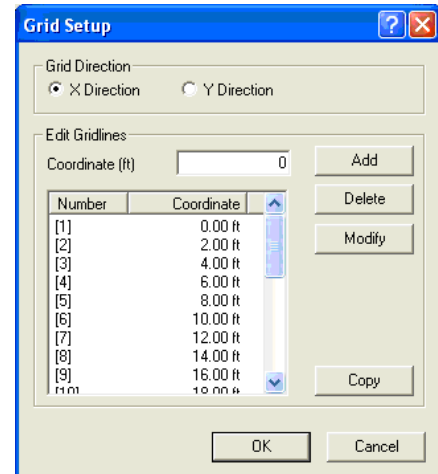

To Delete Grid Lines:

- Select the grid line you wish to delete and choose the DELETE button.

To Edit the Position of a Grid Line:

- Select the grid line you wish to edit, change its location by overwriting the value that is displayed in the COORDINATE text box and choose the MODIFY button.

To Generate Grid Lines:

Grid Lines that are spaced at equal intervals may be generated by inputting the coordinate (distance from the origin) of the first grid line, the number of grid lines and the spacing between two consecutive grid lines.

- With the Grid tab surfaced, double-click on GENERATE... found in the right ITEM LISTING AREA to have the program surface the following...
- To generate grids in the X-direction, place a checkmark in the X-Direction checkbox. To generate grids in the Y-Direction, place a checkmark in the Y Direction check box. Recall that grids in the X-Direction are perpendicular to the X-axis and those in the Y-Direction are perpendicular to the Y-axis.
- For each direction, enter the coordinate of the first grid line to be generated, the number of grid lines to be generated (including the first one) and the spacing between two consecutive grid lines.
- Click on the GENERATE button to have the program generate the respective grid lines.

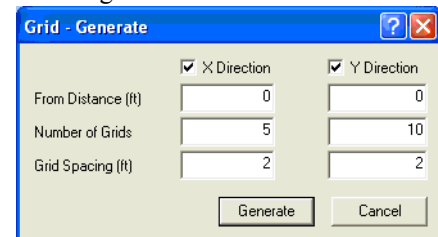

To Remove all Grid Lines:

- Double-click on RESET... found in the right ITEM LISTING AREA to have the program surface the following...
- Note that if you choose to proceed, any material properties, loads, etc. that have already been assigned will have to be re-assigned.
- After confirming your intention, all the grid lines will be removed.

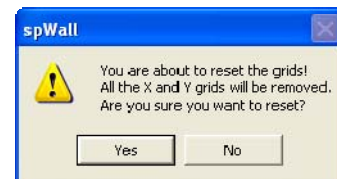

Importing Grid Lines

- Double-click on IMPORT... found in the right ITEM LISTING AREA or alternatively chose **File / Import / Grid...** to have the program display the following Open dialog box

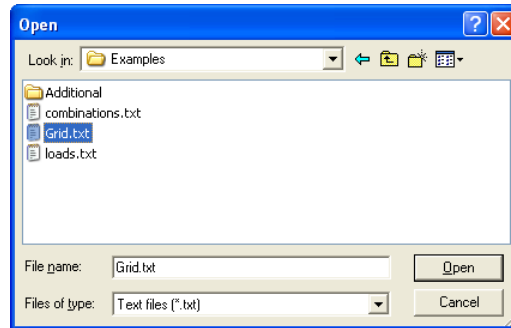

- All files with the TXT extension contained in the current drive and directory are displayed in the FILE NAME list box.
- To open a file that exists in another drive or directory, select the drive or directory you want from the LOOK IN drop-down list.
- From the FILE NAME list box, select the file to be opened, or simply type its name in the text box.
- Choose the OPEN button.

Note: Refer to Import File Formats section of the Appendix for description of the grid import file.

To Choose Grid View Preferences:

- Double-click on PREFERENCES... found in the right ITEM LISTING AREA to have the program surface the following...

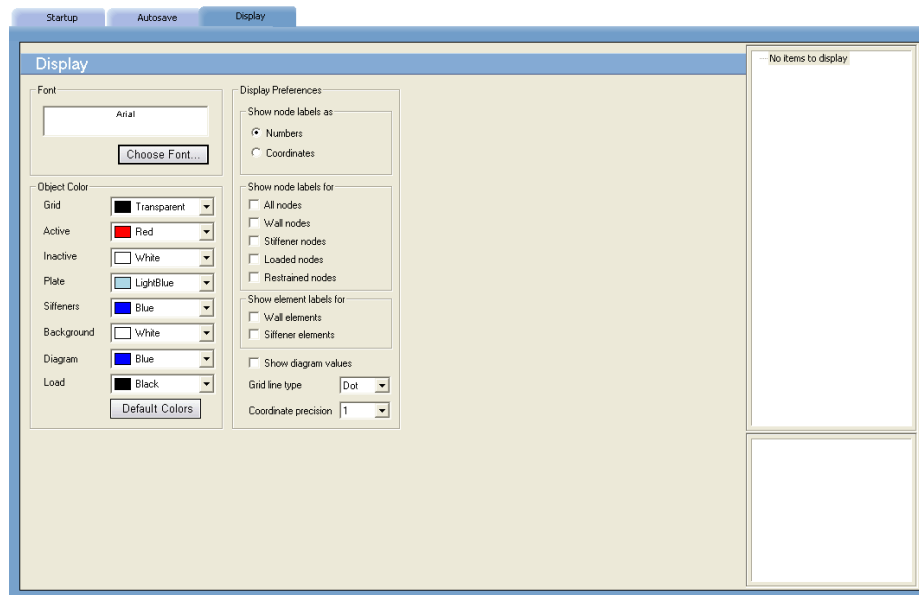

- If you wish for the grid to display the Node Numbers and/or the Element Numbers, place checkmarks in the appropriate box(es).
- Select the style of the grid line, Solid or Dotted.
- Specify the Coordinate Precision. This value relates to the precision of the cursor location. (Recall that the location of the cursor is displayed in the Status Bar.)
- Click on OK to register your selections/changes.

To View Grid Coordinates:

In the right ITEM LISTING AREA, click on the symbol next to the X GRID or Y GRID item(s) to expand the list of grid coordinates. Notice how the grid that is selected appears in red in the GRAPHICS/INPUT AREA.

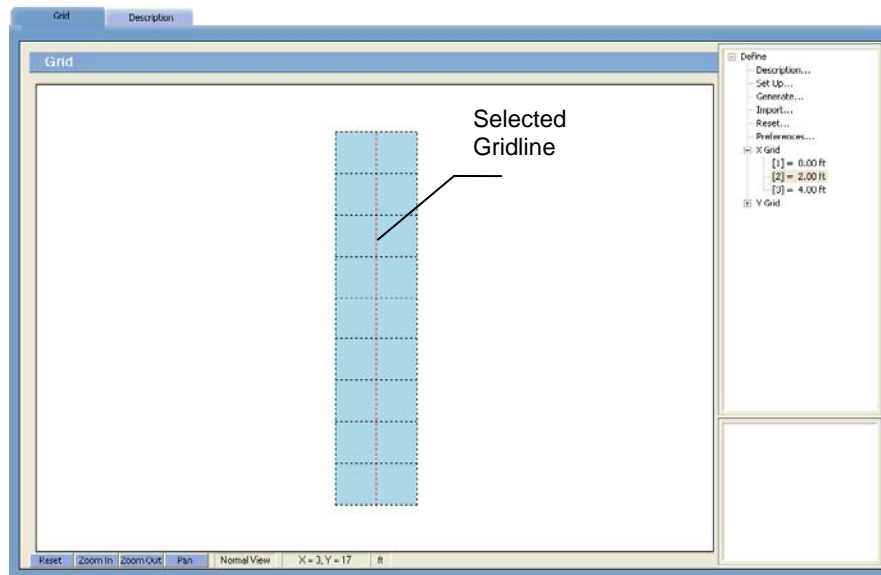

Defining Properties

The following properties can be specified:

- plate element thickness,
- stiffener section properties: section Type, section projection (offset), section dimensions and flange dimensions.
- plate cracking coefficients for the in-plane action and for the out-of-plane (bending) action.
- stiffener cracking coefficients for the cross-section area, the moment of inertia (I_y , I_z) and the torsional constant (J).
- concrete compressive strength (f'_c), Density, Young's modulus (E_c), and Poisson's ratio.
- reinforcement yield strength (f_y), Young's modulus (E_s), minimum/maximum ratios and location.
- From the Define menu, choose Properties to have the program surface the PROPERTIES folder as illustrated here...

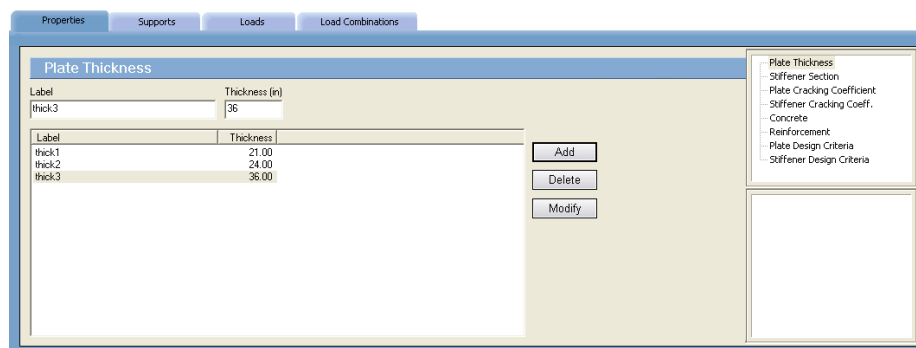

Alternatively, you could have clicked on the **Define** button located on the toolbar, and then on the PROPERTIES tab.

To define plate element thickness:

- Click on PLATE THICKNESS... found in the right ITEM LISTING AREA to have the program surface the PLATE THICKNESS input screen.
- Enter a label or ID in the LABEL text box.
- Enter the thickness in the THICKNESS text box.
- Click on the ADD button to add the entry to the list box.
- Repeat the two steps above for each thickness entry.
- To edit an entry, select it from the list box, modify its value(s) in the text box(es) and click on the MODIFY button to register the changes.
- To delete a thickness entry, select it from the list box and click on the DELETE button.

To define stiffener element section:

- Click on STIFFENER SECTION... found in the right ITEM LISTING AREA to have the program surface the STIFFENER SECTION input screen...

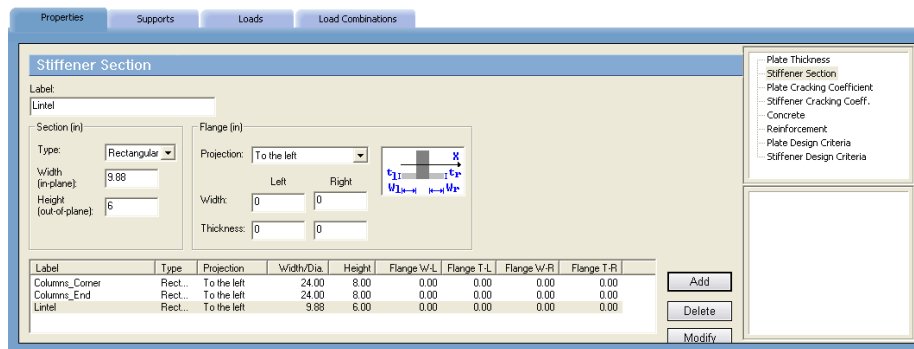

- Enter a label or ID in the LABEL text box.
- Select the corresponding section type from the TYPE combo box
- For rectangular section, enter the width and the height in the WIDTH and the HEIGHT text boxes respectively. Width is measured in the direction of the wall plane while the height is measured normal to the wall plane. For circular section enter the diameter in the WIDTH text box.
- Select the section projection from the PROJECTION combo box. The projection determines the position of the flange along the height of the section. For rectangular sections, there are 3 choices: to the left, to the right and at the middle. For circular sections, at the middle is the only option.
- Enter the flange width and thickness for the left and the right flanges. The entered dimensions are used to calculate section stiffness during the finite element analysis as well as for flexural design. For design due torsion, flange dimensions are reduced as explained in Chapter 2.
- Click on the ADD button to add the entry to the list box.
- Repeat the steps outlined above for each new entry.
- To edit an entry, select it from the list box, modify its values in the text boxes and click on the MODIFY button to register the changes.
- To delete an entry, select it from the list box and click on the DELETE button.

To define plate cracking coefficients:

- Click on PLATE CRACKING COEFFICIENTS... found in the right ITEM LISTING AREA to have the program surface the Plate CRACKING COEFFICIENTS input screen...

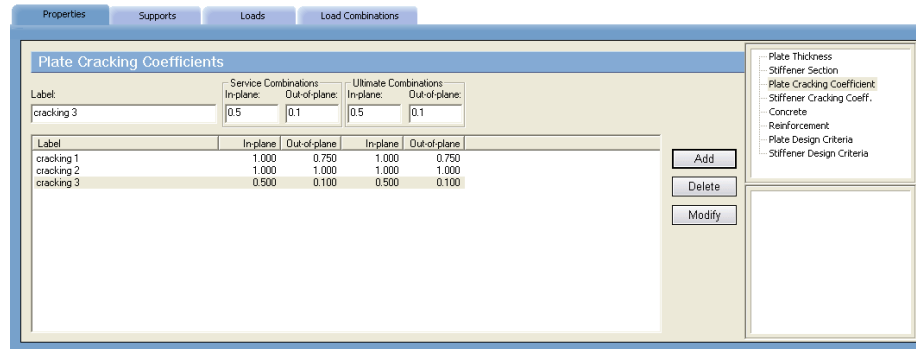

- Enter a label or ID in the LABEL text box.
- Enter the in-plane and out-of-plane coefficients for service and ultimate load combinations in the respective text boxes. Cracking coefficients reduce the plate element stiffness used in the finite element analysis in order to account for the concrete section cracking.
- Click on the ADD button to add the entry to the list box.
- Repeat the steps outlined above for each new entry.
- To edit an entry, select it from the list box, modify its values in the text boxes and click on the MODIFY button to register the changes.
- To delete an entry, select it from the list box and click on the DELETE button.

To define stiffener cracking coefficients:

- Click on STIFFENER CRACKING COEFFICIENTS... found in the right ITEM LISTING AREA to have the program surface the Stiffener Cracking Coefficients INPUT SCREEN...

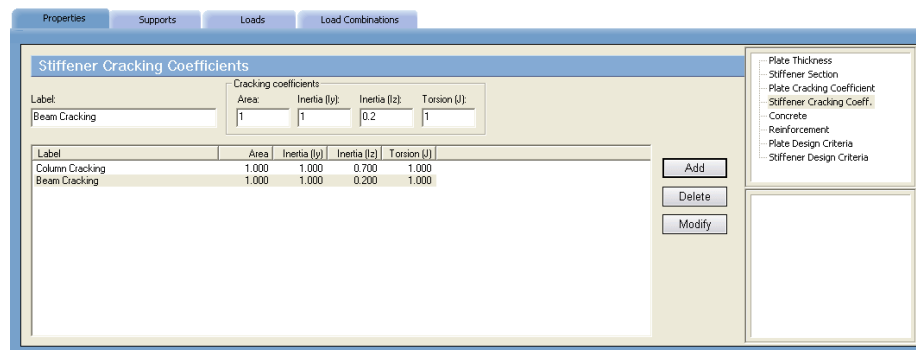

- Enter a label or ID in the LABEL text box.
- Enter the coefficients for the Area, Iy, Iz and J in the respective text boxes. Cracking coefficients reduce the stiffener element stiffness used in the finite element analysis in order to account for the concrete section cracking.
- Click on the ADD button to add the entry to the list box.
- Repeat the steps outlined above for each new entry.
- To edit an entry, select it from the list box, modify its values in the text boxes and click on the MODIFY button to register the changes.
- To delete an entry, select it from the list box and click on the DELETE button.

To define concrete properties:

- Click on CONCRETE... found in the right ITEM LISTING AREA to have the program surface the CONCRETE input screen...

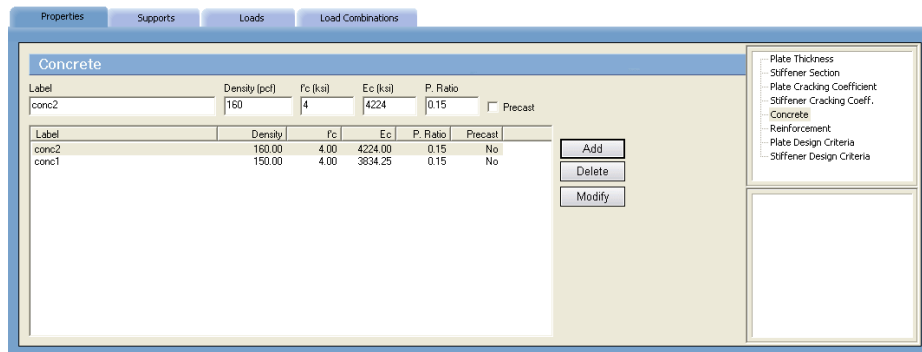

- Enter a label or ID in the LABEL text box.
- Enter the Compressive Strength (f'_c) and Density in the respective text boxes.
- The Young's Modulus of elasticity (E_c) is calculated automatically and will display a result that is respective of the equations in the selected Code. Note that the value of E_c can be modified if it differs from the calculated value.
- Enter the Poisson's Ratio for the concrete
- Check Precast checkbox if precast concrete is used. Lower value of minimum reinforcement ratio is allowed for precast concrete than for cast-in-place concrete in all supported design codes. Also a higher value of resistance factor for concrete, ϕ_c , is assumed in CSA A23.3-04 standard.
- Click on the ADD button to add the entry to the list box.
- Repeat the steps outlined above for each new entry.
- To edit an entry, select it from the list box, modify its values in the text boxes and click on the MODIFY button to register the changes.
- To delete an entry, select it from the list box and click on the DELETE button.

To define reinforcing steel properties:

- Click on REINFORCEMENT... found in the right ITEM LISTING AREA to have the program surface the REINFORCEMENT input screen...

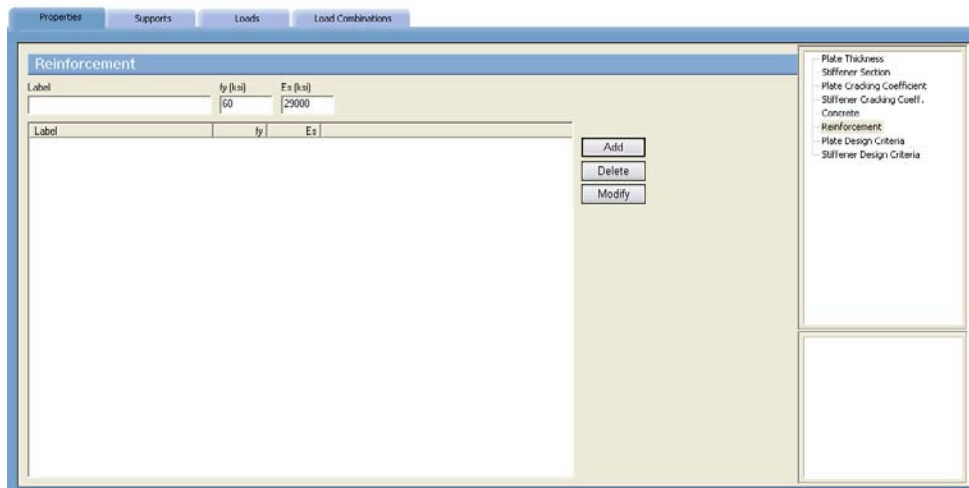

- Enter a label or ID in the LABEL text box.
- Enter the Yield Strength (f_y) and the Young's Modulus of elasticity (E_s) for the steel.
- Click on the ADD button to add the entry to the list box.
- Repeat the above steps for each reinforcement entry.
- To edit an entry, select it from the list box, modify its values in the text boxes and click on the MODIFY button to register the changes.
- To delete a material entry, select it from the list box and click on the DELETE button.

To define plate design criteria:

- Click on PLATE DESIGN CRITERIA... found in the right ITEM LISTING AREA to have the program surface the PLATE DESIGN CRITERIA Input screen.
- Enter a label or ID in the LABEL text box

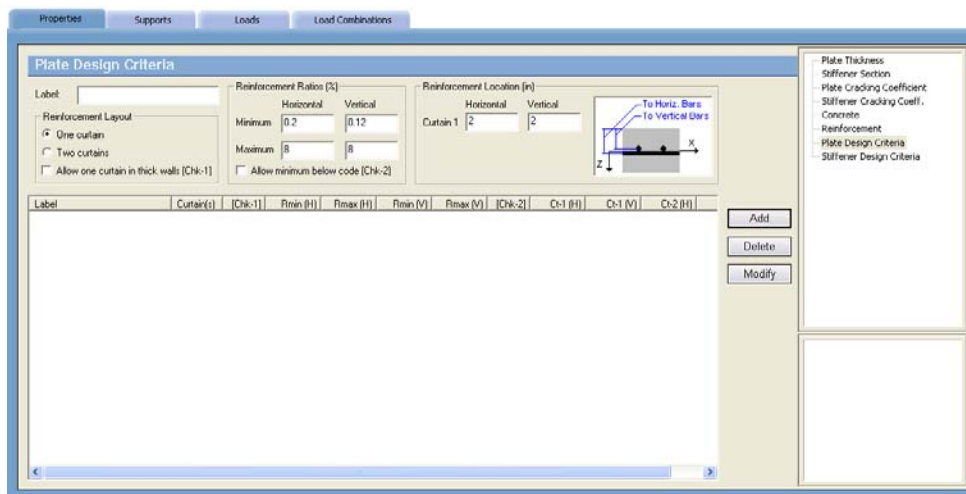

- Select the Number of reinforcement layers. If one curtain reinforcement layout is selected for walls thicker than 10 in [250 mm] and you want the program to suppress warning that one layer should not be used in thick walls, select the ALLOW ONE CURTAIN IN THICK WALLS option. If the TWO CURTAINS option is selected, the calculated total area of reinforcement is assumed to be equally distributed between each curtain, i.e. each curtain receives half of the total area reported by the program in the results.
- Specify the bar locations for the bars running in the X and Y directions. The location is measured from the left side of the wall to the centroid of the bar. If the TWO CURTAINS option is selected, the location of each curtain is allowed to be entered individually.
- Enter the minimum and maximum ratios for reinforcement running in the X and Y directions. If the minimum reinforcement ratio entered is below the code specified value, the program will use the code minimum unless the ALLOW MINIMUM BELOW CODE option is checked
- Click on the ADD button to add the entry to the list box.
- Repeat the above steps for each new entry.
- To edit an entry, select it from the list box, modify its values in the text boxes and click on the MODIFY button to register the changes.
- To delete an entry, select it from the list box and click on the DELETE button.

To define stiffener design criteria:

- Click on STIFFENER DESIGN CRITERIA... found in the right ITEM LISTING AREA to have the program surface the STIFFENER DESIGN CRITERIA input screen.
- Enter a label or ID in the LABEL text box
- Select the REINF. LAYOUT. The various options are illustrated below.

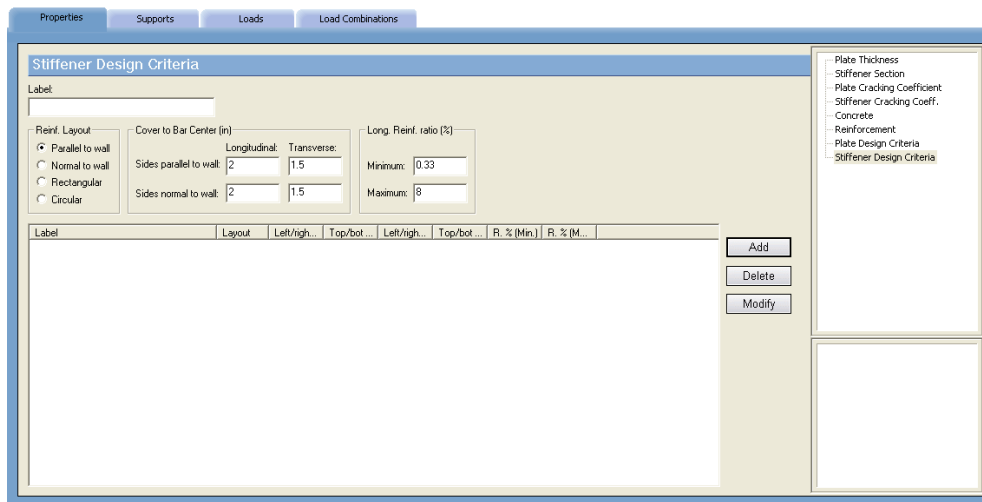
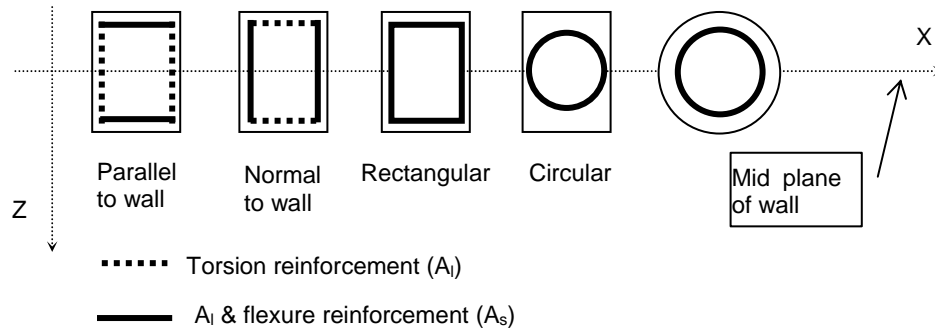

The above mentioned options are for the part of longitudinal reinforcement that resists flexure and axial loads. The part of longitudinal reinforcement that resists torsion is either rectangular or circular depending on the selected layout.

Also, it should be mentioned that for stiffener elements that have circular sections, circular layout is the only option that can be applied to those elements.

- Enter the cover to longitudinal and transverse reinforcements. Cover is measured from the section side to the centroid of bar.
- Enter the minimum and maximum ratios for longitudinal reinforcement. These ratios are used to check flexural design only. When torsional longitudinal reinforcement is required the total ratio of steel may exceed the maximum value specified here.
- Click on the ADD button to add the entry to the list box.
- Repeat the above steps for each new entry.
- To edit an entry, select it from the list box, modify its values in the text boxes and click on the MODIFY button to register the changes.
- To delete an entry, select it from the list box and click on the DELETE button.

Defining Supports

From the **Define** menu, choose **Supports** to have the program surface the SUPPORTS folder...

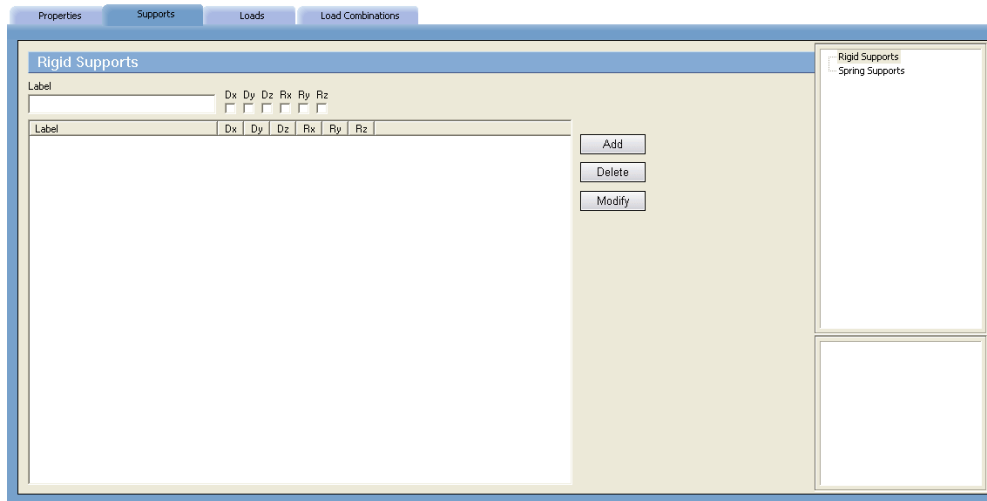

Alternatively, you could have clicked on the **Define** button located on the toolbar, and then click on the SUPPORTS tab.

To define rigid supports:

- Click on RIGID SUPPORTS... found in the right ITEM LISTING AREA to have the program surface the RIGID SUPPORTS input screen.
- Enter a label or ID in the LABEL text box.
- Check the degrees of freedom that are required to be restrained.
- Click on the ADD button to add the entry to the list box.
- Repeat the above steps for each new entry.
- To edit an entry, select it from the list box, modify its values in the text boxes and click on the MODIFY button to register the changes.
- To delete an entry, select it from the list box and click on the DELETE button.

To define spring supports:

- Click on SPRING SUPPORTS... found in the right ITEM LISTING AREA to have the program surface the SPRING SUPPORTS input screen.
- Enter a label or ID in the LABEL text box.
- Enter translational and rotational spring values in the respective text boxes.
- Click on the ADD button to add the entry to the list box.
- Repeat the above steps for each new entry.
- To edit an entry, select it from the list box, modify its values in the text boxes and click on the MODIFY button to register the changes.
- To delete an entry, select it from the list box and click on the DELETE button.

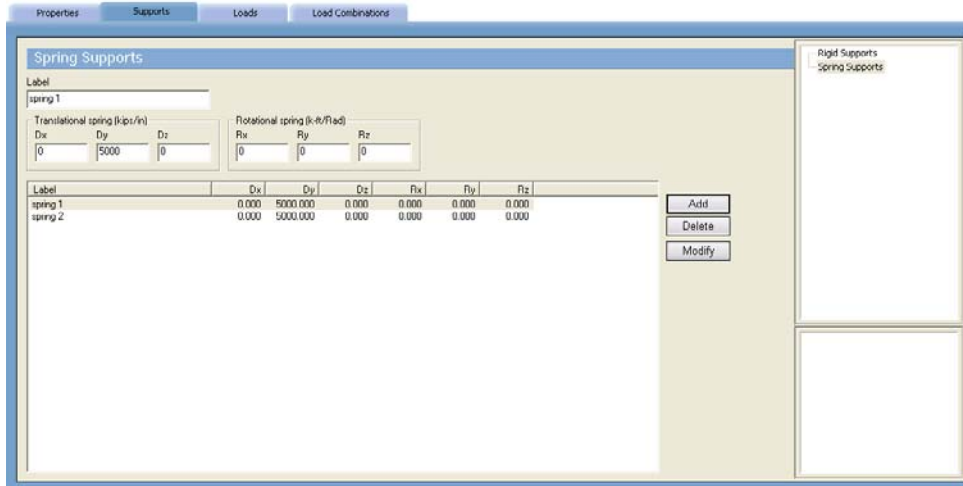

Defining Loads

Nodal and element loads are defined using the **Define / Loads** command. From the **Define** menu, choose **Loads** to have the program surface the LOADS folder. Alternatively, you could have clicked on the **Define** button located on the toolbar, and then on the LOADS tab.

To define point loads:

- Click on POINT LOADS... found in the right ITEM LISTING AREA to have the program surface the POINT LOADS input screen...

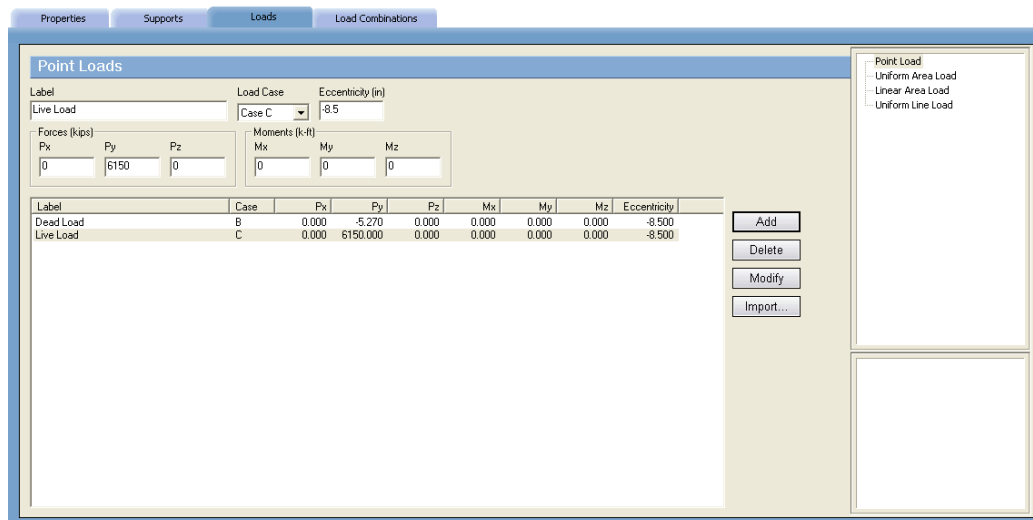

- Enter a label or ID in the LABEL text box.
- From the Load Case drop-down list, select a load case (A through F). Note that loads defined under a particular load case may be applied to the wall under that load case only.
- Enter Eccentricity that is measured in the Z direction normal to the mid plane of the wall. If eccentricity is specified, additional moments will be applied at the node at which the point load is acting as explained in Chapter 2.
- Enter forces (Px, Py and Pz) and moments (Mx, My and Mz). Note that forces are positive if they act in the positive direction of the corresponding axis. To determine the sign of the moments use the right hand rule.

- Click on the ADD button to add the entry to the list box.
- Repeat the above steps for each new entry.
- To edit an entry, select it from the list box, modify its values in the text boxes and click on the MODIFY button to register the changes.
- To delete an entry, select it from the list box and click on the DELETE button.

To define uniform area loads:

- Click on UNIFORM AREA LOADS... found in the right ITEM LISTING AREA to have the program surface the UNIFORM AREA LOADS input screen...
- Enter a label ID in the LABEL text box.
- From the Load Case drop-down list, select a load case (A through F). Note that loads defined under a particular load case may be applied to the wall under that load case only.
- Enter the load intensity W_x , W_y and W_z as a force per unit area. Note that forces are positive if they act in the positive direction of the corresponding axis.

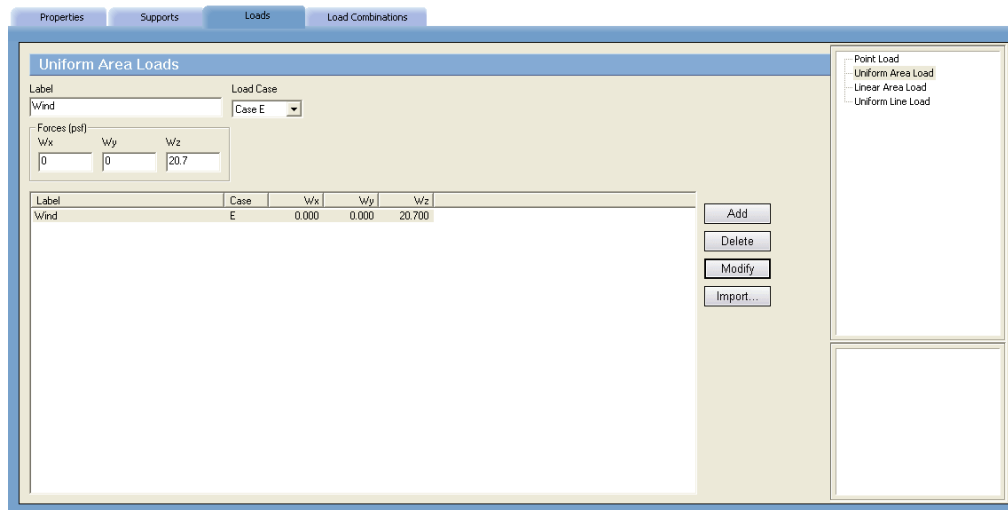

Label	Case	W_x	W_y	W_z
Wind	E	0.000	0.000	20.700

- Click on the ADD button to add the entry to the list box.
- Repeat the above steps for each entry.
- To edit an entry, select it from the list box, modify its values in the text boxes and click on the MODIFY button to register the changes.
- To delete an entry, select it from the list box and click on the DELETE button.

To define linear area loads:

- Click on LINEAR AREA LOADS... found in the right ITEM LISTING AREA to have the program surface the Linear Area Loads input screen below.
- Enter a label ID in the LABEL text box.
- From the Load Case drop-down list, select a load case (A through F). Note that loads defined under a particular load case may be applied to the wall under that load case only.
- Enter Y_1 and Y_2 . These are the two Y-coordinates at which the load intensities are specified.
- Enter the load intensity W_x , W_y and W_z as a force per unit area at both Y_1 and Y_2 . Note that forces are positive if they act in the positive direction of the corresponding axis.

- Click on the ADD button to add the entry to the list box.
- Repeat the above steps for each entry.
- To edit an entry, select it from the list box, modify its values in the text boxes and click on the MODIFY button to register the changes.
- To delete an entry, select it from the list box and click on the DELETE button.

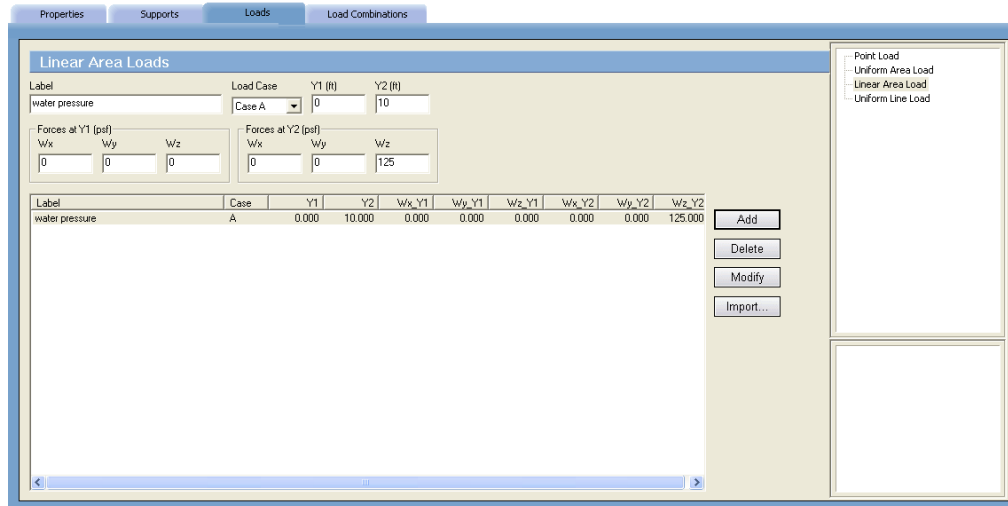

To define uniform line loads:

- Click on UNIFORM LINE LOADS... found in the right ITEM LISTING AREA to have the program surface the UNIFORM LINE LOADS input screen...

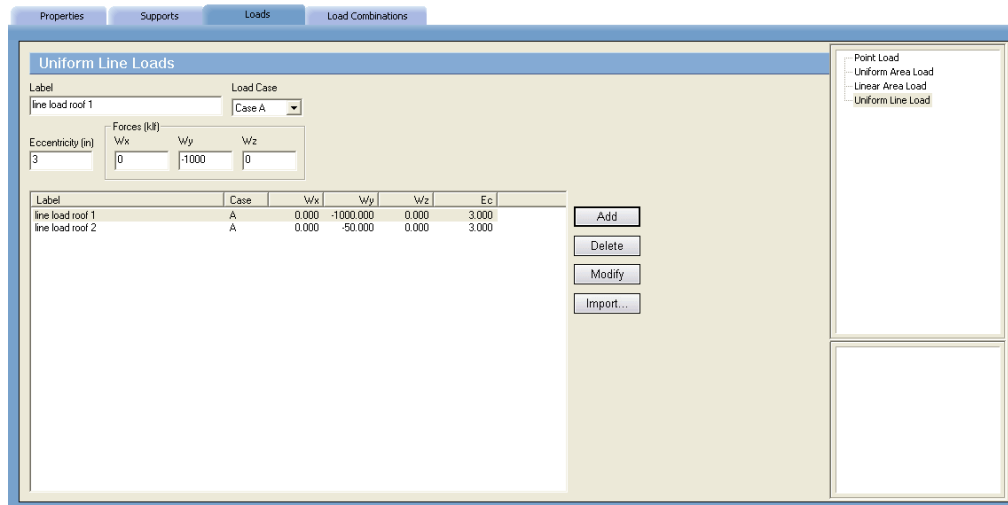

- Enter a label or ID in the LABEL text box.
- From the Load Case drop-down list, select a load case (A through F). Note that loads defined under a particular load case may be applied to the wall under that load case only.
- Enter Eccentricity that is measured in the Z direction normal to the mid plane of the wall. If eccentricity is specified, additional moments will be applied at the node at which the point load is acting as explained in Chapter 2.
- Enter forces (Wx, Wy and Wz). Note that forces are positive if they act in the positive direction of the corresponding axis.

- Click on the ADD button to add the entry to the list box.
- Repeat the above steps for each new entry.
- To edit an entry, select it from the list box, modify its values in the text boxes and click on the MODIFY button to register the changes.
- To delete an entry, select it from the list box and click on the DELETE button.

To Import Loads from Text File

- Click the IMPORT... button or alternatively chose **File / Import / Loads...** to have the program display the following Open dialog box

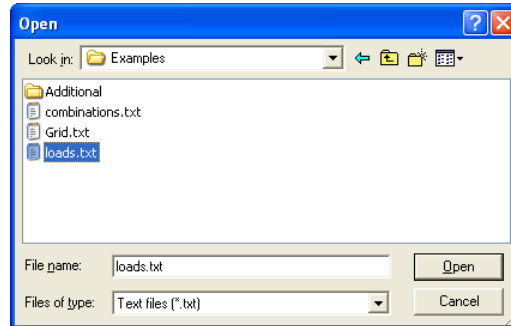

- All files with the TXT extension contained in the current drive and directory are displayed in the FILE NAME list box.
- To open a file that exists in another drive or directory, select the drive or directory you want from the LOOK IN drop-down list.
- From the FILE NAME list box, select the file to be opened, or simply type its name in the text box.
- Choose the OPEN button.

Note: Refer to Import File Formats section of the Appendix for description of the load import file.

Defining Load Combinations

Loads are applied to nodes and elements under six load cases (A through F). The load cases are combined under load combinations and the analysis is performed for each load combination. For model analysis to be performed, there should be one service and one ultimate load combinations defined.

From the **Define** menu, choose **Load Combinations** to have the program surface the LOAD COMBINATIONS folder as illustrated here. Alternatively, you could have clicked on the **Define** button located on the toolbar, and then on the LOAD COMBINATIONS tab.

To define service load combinations:

- Click on SERVICE... found in the right ITEM LISTING AREA to have the program surface the SERVICE LOAD COMBINATIONS input screen.
- Enter a label or ID in the LABEL text box.
- Enter load factors for each load case (A through F).
- Click the ADD button to add the load combination to the list box.
- Repeat above steps for each load combination entry.
- To edit an entry, select it from the list box, modify its values in the text boxes and click on the MODIFY button to register the changes.

- To delete an entry, select it from the list box and click on the DELETE button.

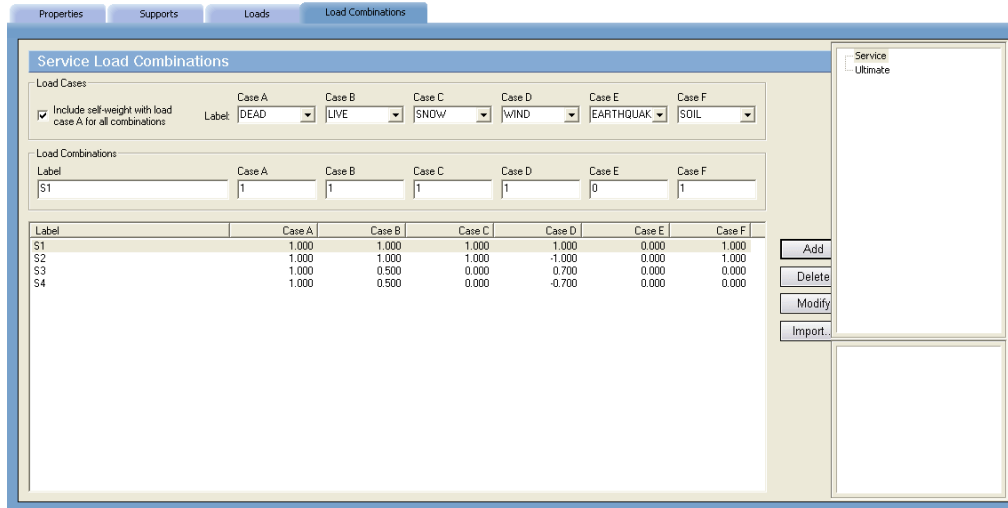

To define ultimate load combinations:

- Click on ULTIMATE... found in the right ITEM LISTING AREA to have the program surface the ULTIMATE LOAD COMBINATIONS input screen.
- Enter a label or ID in the LABEL text box.
- Enter load factors for each load case (A through F).
- Click the ADD button to add the load combination to the list box.
- Repeat the above steps for each load combination entry.
- To edit an entry, select it from the list box, modify its values in the text boxes and click on the MODIFY button to register the changes.
- To delete an entry, select it from the list box and click on the DELETE button.

To import load combinations from text file

- Click the IMPORT... button or alternatively chose **File / Import / Combinations...** to have the program display the following Open dialog box

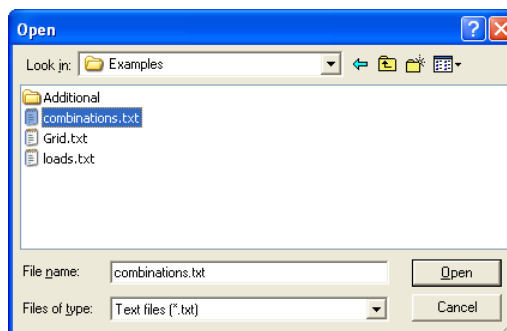

- All files with the TXT extension contained in the current drive and directory are displayed in the FILE NAME list box.
- To open a file that exists in another drive or directory, select the drive or directory you want from the LOOK IN drop-down list.
- From the FILE NAME list box, select the file to be opened, or simply type its name in the text box.

- Choose the OPEN button.

Note: Refer to Import File Formats section of the Appendix for description of the load combinations import file.

Assigning Properties

Once the grid, all components, material properties, design criteria, loads, and load combinations have been defined, you are ready to start assigning them - thereby putting the project together. To facilitate assignment of properties, options to show the element and node labels are provided in the pop-up menu accessible by right-clicking on any blank portion of the screen.

- From the Assign menu, choose Properties to have the program surface the PROPERTIES folder as illustrated here...

Alternatively, you could have clicked on the  button located on the toolbar, and then on the PROPERTIES tab.

To assign plate element thickness:

- Click on the  symbol next to Plate Thickness... found in the right ITEM LISTING AREA to expand the Plate Thickness list. The list items that will appear are those defined using the **Define / Plate Thickness** command. See To define plate element thickness.
- Select the list item to be assigned. This becomes the active assignment. By default, the program will display all elements that share the active assignment in red and the inactive assignment in cyan. Unassigned grid space is by default displayed in white. Recall however that you may change the color preferences to your liking with the **Options / Display Preferences** command. See To change display preferences.
- In the Graphics Area, using the left-mouse button, marquee-select a grid space or a group of grid spaces (or click a single grid space). The selected grid spaces are shown in red or in the color specified for Active Objects in the DISPLAY folder. See To change display preferences.
- To delete an element, remove its thickness assignment. To do so, repeat the step above using instead, the right mouse button.
- Repeat the three steps above for each thickness assignment.

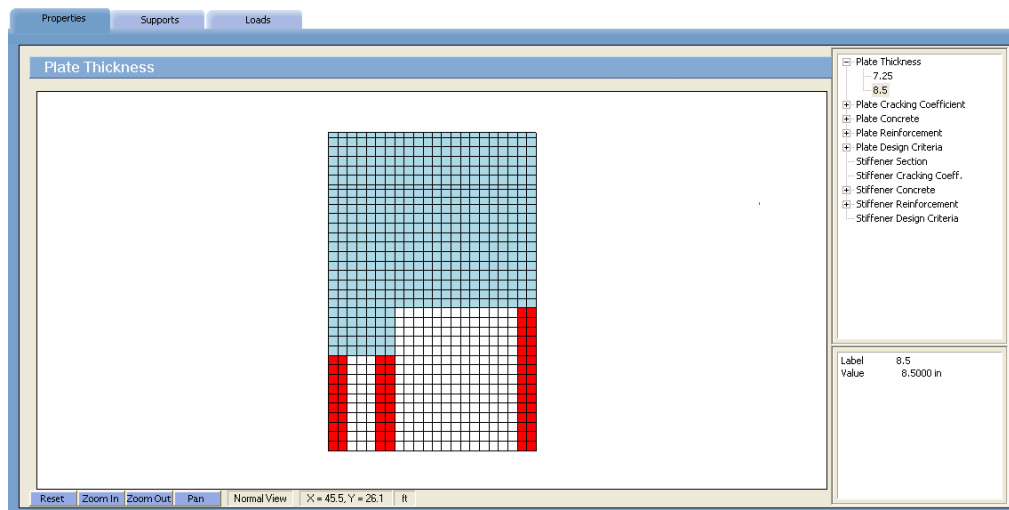

To assign plate cracking coefficient:

- Click on the  symbol next to Plate Cracking Coefficients... found in the right ITEM LISTING AREA to expand the Plate Cracking Coefficients list. The list items that will appear are those defined using the **Define / Plate Cracking Coefficients** command. See To define plate cracking coefficients.
- Select the list item to be assigned. This becomes the active assignment. By default, the program will display all plate elements that share the active assignment in red and the inactive assignment in cyan. Plate elements having no assignments are by default displayed in light grey. Grid spaces with no plate element assigned are by default displayed in white. Recall however that you may change the color preferences to your liking with the **Options / Display Preferences** command. See To change display preferences.
- In the Graphics Area, using the left-mouse button, marquee-select a plate element or a group of elements (or click a single plate element). The selected elements are shown in red or in the color specified for Active Objects in the DISPLAY folder. See To change display preferences.
- To remove the assignment, repeat the step above using instead, the right mouse button.
- Repeat the steps above for each assignment.

To assign plate concrete material:

- Click on the  symbol next to Plate Concrete... found in the right ITEM LISTING AREA to expand the Plate Concrete list. The list items that will appear are those defined using the **Define / Concrete** command. See To define concrete properties.
- Select the list item to be assigned. This becomes the active assignment. By default, the program will display all plate elements that share the active assignment in red and the inactive assignment in cyan. Plate elements having no assignments are by default displayed in light grey. Grid spaces with no plate element assigned are by default displayed in white. Recall however that you may change the color preferences to your liking with the **Options / Display Preferences** command. See To change display preferences.
- In the Graphics Area, using the left-mouse button, marquee-select a plate element or a group of elements (or click a single plate element). The selected plate elements are shown in red or in the color specified for Active Objects in the DISPLAY folder. See To change display preferences.
- To remove the assignment, repeat the step above using instead, the right mouse button.
- Repeat the steps above for each assignment.

To assign plate reinforcing steel material:

- Click on the  symbol next to Plate Reinforcement... found in the right ITEM LISTING AREA to expand the Plate Reinforcement list. The list items that will appear are those defined using the **Define / Reinforcement** command. See To define reinforcing steel properties.
- Select the list item to be assigned. This becomes the active assignment. By default, the program will display all plate elements that share the active assignment in red and the inactive assignment in cyan. Plate elements having no assignments are by default displayed in light grey. Grid spaces with no plate element assigned are by default displayed in white. Recall however that you may change the color preferences to your liking with the **Options / Display Preferences** command. See To change display preferences.
- In the Graphics Area, using the left-mouse button, marquee-select a plate element or a group of elements (or click a single plate element). The selected plate elements are shown in red or in the color specified for Active Objects in the DISPLAY folder. See To change display preferences.
- To remove the assignment, repeat the step above using instead, the right mouse button.
- Repeat the steps above for each assignment.

To assign plate design criteria:

- Click on the  symbol next to Plate Design Criteria... found in the right ITEM LISTING AREA to expand the Plate Design Criteria list. The list items that will appear are those defined using the **Define / Plate Design Criteria** command. See To define plate design criteria.
- Select the list item to be assigned. This becomes the active assignment. By default, the program will display all plate elements that share the active assignment in red and the inactive assignment in cyan. Plate elements having no assignments are by default displayed in light grey. Grid spaces with no plate element assigned are by default displayed in white. Recall however that you may change the color preferences to your liking with the **Options / Display Preferences** command. See To change display preferences.
- In the Graphics Area, using the left-mouse button, marquee-select a plate element or a group of elements (or click a single plate element). The selected plate elements are shown in red or in the color specified for Active Objects in the DISPLAY folder. See To change display preferences.
- To remove the assignment, repeat the step above using instead, the right mouse button.
- Repeat the steps above for each assignment.

To assign stiffener element section:

- Click on the  symbol next to Stiffener Section... found in the right ITEM LISTING AREA to expand the Stiffener Section list. The list items that will appear are those defined using the **Define / Stiffener Section** command. See To define stiffener element section.
- Select the list item to be assigned. This becomes the active assignment. By default, the program will display all stiffener elements that share the active assignment in red and the inactive assignment in cyan. . Stiffener elements having no assignments are by default displayed in blue. Recall however that you may change the color preferences to your liking with the **Options / Display Preferences** command. See To change display preferences.
- In the Graphics Area, using the left-mouse button, marquee-select a grid segment or a group of grid segments. The selected grid segments are shown in red or in the color specified for Active Objects in the DISPLAY folder. See To change display preferences.
- To delete an element, remove its section assignment. To do so, repeat the step above using instead, the right mouse button.
- Repeat the three steps above for each section assignment.

To assign stiffener cracking coefficient:

- Click on the  symbol next to Stiffener Cracking Coefficients... found in the right ITEM LISTING AREA to expand the Stiffener Cracking Coefficients list. The list items that will appear are those defined using the **Define / Stiffener Cracking Coefficients** command. See To define stiffener cracking coefficients.
- Select the list item to be assigned. This becomes the active assignment. By default, the program will display all stiffener elements that share the active assignment in red and the inactive assignment in cyan. . Stiffener elements having no assignments are by default displayed in blue. Recall however that you may change the color preferences to your liking with the **Options / Display Preferences** command. See To change display preferences.
- In the Graphics Area, using the left-mouse button, marquee-select a stiffener element or a group of stiffener elements. The selected stiffener elements are shown in red or in the color specified for Active Objects in the DISPLAY folder. See To change display preferences.
- To remove the assignment, repeat the step above using instead, the right mouse button.
- Repeat the steps above for each assignment.

To assign stiffener concrete material:

- Click on the  symbol next to Stiffener Concrete... found in the right ITEM LISTING AREA to expand the Stiffener Concrete list. The list items that will appear are those defined using the **Define / Concrete** command. See To define concrete properties.
- Select the list item to be assigned. This becomes the active assignment. By default, the program will display all stiffener elements that share the active assignment in red and the inactive assignment in cyan. Stiffener elements having no assignments are by default displayed in blue. Recall however that you may change the color preferences to your liking with the **Options / Display Preferences** command. See To change display preferences.
- In the Graphics Area, using the left-mouse button, marquee-select a stiffener element or a group of stiffener elements. The selected stiffener elements are shown in red or in the color specified for Active Objects in the DISPLAY folder. See To change display preferences.
- To remove the assignment, repeat the step above using instead, the right mouse button.
- Repeat the steps above for each assignment.

To assign stiffener reinforcing steel material:

- Click on the  symbol next to Stiffener Reinforcement... found in the right ITEM LISTING AREA to expand the Stiffener Reinforcement list. The list items that will appear are those defined using the **Define / Reinforcement** command. See To define reinforcing steel properties.
- Select the list item to be assigned. This becomes the active assignment. By default, the program will display all stiffener elements that share the active assignment in red and the inactive assignment in cyan. Stiffener elements having no assignments are by default displayed in blue. Recall however that you may change the color preferences to your liking with the **Options / Display Preferences** command. See To change display preferences.
- In the Graphics Area, using the left-mouse button, marquee-select a stiffener element or a group of stiffener elements. The selected stiffener elements are shown in red or in the color specified for Active Objects in the DISPLAY folder. See To change display preferences.
- To remove the assignment, repeat the step above using instead, the right mouse button.
- Repeat the steps above for each assignment.

To assign stiffener design criteria:

- Click on the  symbol next to Stiffener Design Criteria... found in the right ITEM LISTING AREA to expand the Stiffener Design Criteria list. The list items that will appear are those defined using the **Define / Stiffener Design Criteria** command. See To define stiffener design criteria.
- Select the list item to be assigned. This becomes the active assignment. By default, the program will display all stiffener elements that share the active assignment in red and the inactive assignment in cyan. Stiffener elements having no assignments are by default displayed in blue. Recall however that you may change the color preferences to your liking with the **Options / Display Preferences** command. See To change display preferences.
- In the Graphics Area, using the left-mouse button, marquee-select a stiffener element or a group of stiffener elements. The selected stiffener elements are shown in red or in the color specified for Active Objects in the DISPLAY folder. See To change display preferences.
- To remove the assignment, repeat the step above using instead, the right mouse button.
- Repeat the steps above for each assignment.

Assigning Supports

Once plate and stiffener elements are assigned, the program creates finite element nodes. A node is a grid intersection that has an element or more connected to it. Supports are assigned only to nodes. To facilitate assignment of supports, options to show the element and node labels are provided in the pop-up menu accessible by right-clicking on any blank portion of the screen.

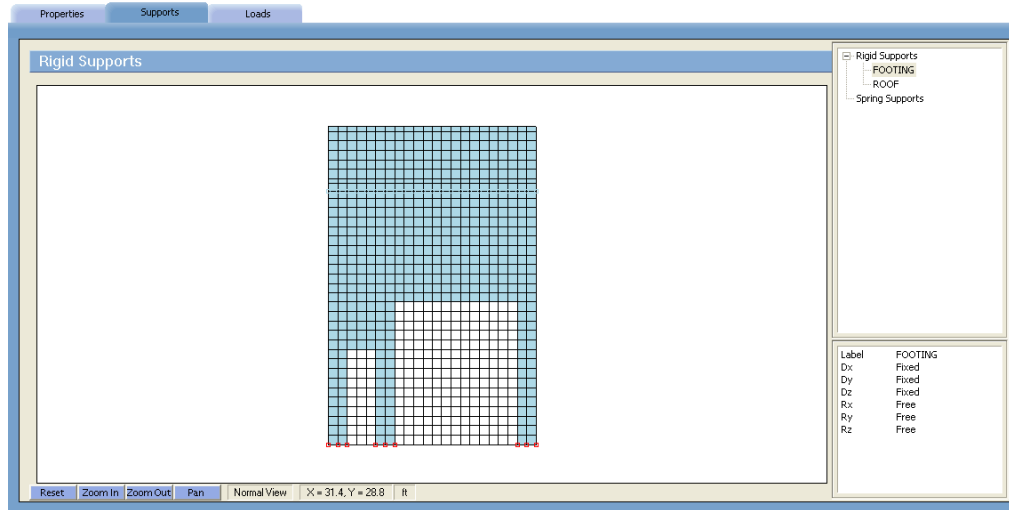

- From the Assign menu, choose Supports surface the SUPPORTS folder as illustrated above...

Alternatively, you could have clicked on the **Assign** button located on the toolbar, and then on the SUPPORTS tab.

To assign rigid supports:

- Click on the symbol next to Rigid Supports ... found in the right ITEM LISTING AREA to expand the Rigid Supports list. The list items that will appear are those defined using the **Define / Supports / Rigid Supports** command. See To define rigid supports.
- Select a list item to be assigned. This becomes the active assignment. By default, the program will display all nodes that share the active assignment in red and nodes with a different assignment in cyan. Recall however that you may change the color preferences to your liking with the **Options / Display Preferences** command. See To change display preferences.
- In the Graphics Area, using the left-mouse button, marquee-select a node or a group of nodes (or click a single node). The selected nodes are shown in red or in the color specified for Active Objects in the DISPLAY folder. See To change display preferences.
- To remove the assignment, repeat the step above using instead, the right mouse button.
- Repeat the steps above for each assignment.

To assign spring supports:

- Click on the symbol next to Spring Supports ... found in the right ITEM LISTING AREA to expand the Spring Supports list. The list items that will appear are those defined using the **Define / Supports / Spring Supports** command. See To define spring supports.
- Select a list item to be assigned. This becomes the active assignment. By default, the program will display all nodes that share the active assignment in red and nodes with a different assignment in cyan. Recall however that you may change the color preferences to your liking with the **Options / Display Preferences** command. See To change display preferences.

- In the Graphics Area, using the left-mouse button, marquee-select a node or a group of nodes (or click a single node). The selected nodes are shown in red or in the color specified for Active Objects in the DISPLAY folder. See To change display preferences.
- To remove the assignment, repeat the step above using instead, the right mouse button.
- Repeat the steps above for each assignment.

Applying Loads

Once plate and stiffener elements are assigned, the program creates finite element nodes. A node is a grid intersection that has an element or more connected to it. Point loads are assigned to nodes. Line loads are assigned to either stiffener elements or to the edges of plate elements. Area loads are assigned to plate elements. Loads transferred to the wall from openings (e.g. self weight and wind loads on doors or windows) should also be considered in the model. Equivalents of these loads can be applied by the user as point or line loads along the edges of the openings.

To have the loads annotated during this assignment phase, right-click on a blank portion of the screen to find load annotation options within the pop-up menu. This menu also has the options to show element and node labels similar to the other assignment screens.

- From the **Assign** menu, choose **Loads** to have the program surface the LOADS folder

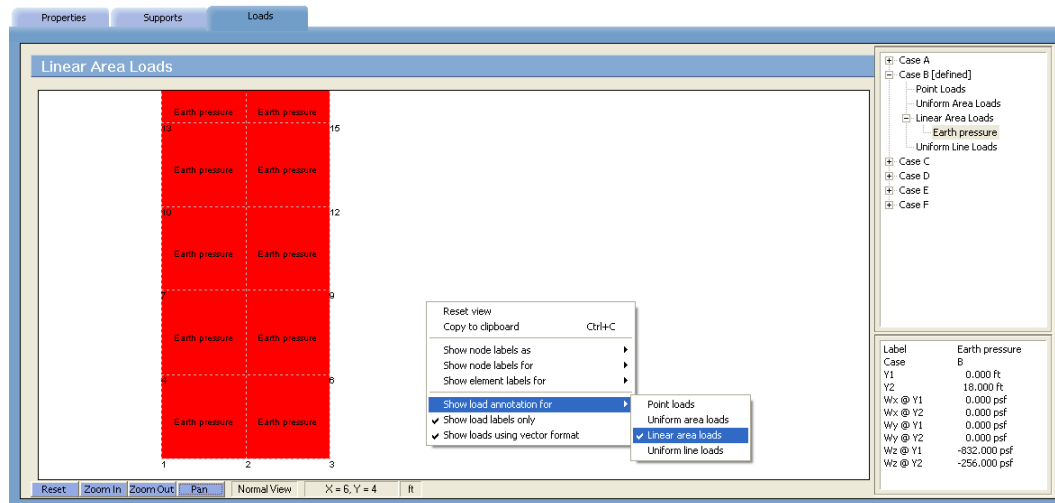

- Alternatively, you could have **clicked** on the **Assign** button located on the toolbar, and then on the LOADS tab.

To assign point loads:

- Click on the symbol next to required load case (Case A, Case B etc.) found in the right ITEM LISTING AREA to expand the list. Click on the symbol next to Point Loads. The list items that will appear are those defined using the **Define / Loads / Point Loads** command. See To define point loads.
- Select a list item to be assigned. This becomes the active assignment. By default, the program will display all nodes that share the active assignment in red and nodes with a different assignment in cyan. Recall however that you may change the color preferences to your liking with the **Options / Display Preferences** command. See To change display preferences.
- In the Graphics Area, using the left-mouse button, marquee-select a node or a group of nodes (or click a single node). The selected nodes are shown in red or in the color specified for Active Objects in the DISPLAY folder. See To change display preferences.
- To remove the assignment, repeat the step above using instead, the right mouse button.

- Repeat the steps above for each assignment.

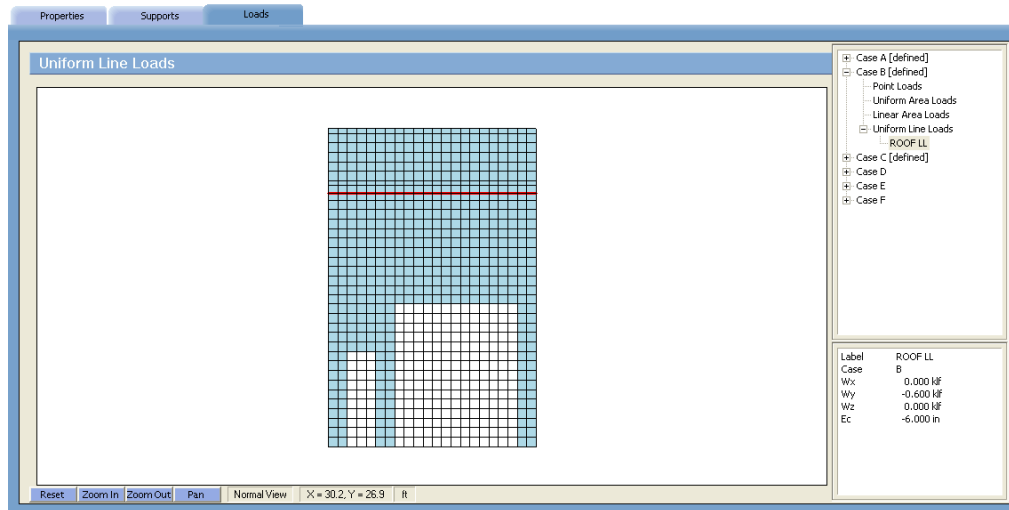

To assign uniform area loads:



- Click on the symbol next to required load case (Case A, Case B etc.) found in the right ITEM LISTING AREA to expand the list. Click on the symbol next to Uniform Area Loads. The list items that will appear are those defined using the **Define / Loads/ Uniform Area Loads** command. See To define uniform area loads.
- Select the list item to be assigned. This becomes the active assignment. By default, the program will display all plate elements that share the active assignment in red and the inactive assignment in cyan. Plate elements having no assignments are by default displayed in light grey. Grid spaces with no plate element assigned are by default displayed in white. Recall however that you may change the color preferences to your liking with the **Options / Display Preferences** command. See To change display preferences.
- In the Graphics Area, using the left-mouse button, marquee-select a plate element or a group of elements (or click a single plate element). The selected plate elements are shown in red or in the color specified for Active Objects in the DISPLAY folder. See To change display preferences.
- To remove the assignment, repeat the step above using instead, the right mouse button.
- Repeat the steps above for each assignment.

To assign linear area loads:

- Click on the symbol next to required load case (Case A, Case B etc.) found in the right ITEM LISTING AREA to expand the list. Click on the symbol next to Linear Area Loads. The list items that will appear are those defined using the **Define / Loads/ Linear Area Loads** command. See To define linear area loads.
- Select the list item to be assigned. This becomes the active assignment. By default, the program will display all plate elements that share the active assignment in red and the inactive assignment in cyan. Plate elements having no assignments are by default displayed in light grey. Grid spaces with no plate element assigned are by default displayed in white. Recall however that you may change the color preferences to your liking with the **Options / Display Preferences** command. See To change display preferences.
- In the Graphics Area, using the left-mouse button, marquee-select a plate element or a group of elements (or click a single plate element). The selected plate elements are shown in red or in the color specified for Active Objects in the DISPLAY folder. See To change display preferences.
- To remove the assignment, repeat the step above using instead, the right mouse button.

- Repeat the steps above for each assignment.

To assign uniform line loads:

- Click on the  symbol next to required load case (Case A, Case B etc.) found in the right ITEM LISTING AREA to expand the list. Click on the  symbol next to Uniform Line Loads. The list items that will appear are those defined using the **Define / Loads/ Uniform Line Loads** command. See To define uniform line loads.
- Select the list item to be assigned. This becomes the active assignment. By default, the program will display all lines that share the active assignment in red and the inactive assignment in cyan. Recall however that you may change the color preferences to your liking with the **Options / Display Preferences** command. See To change display preferences.
- In the Graphics Area, using the left-mouse button, marquee-select a stiffener element, a group of stiffener elements, a plate element edge or a group of plate element edges. The selected lines are shown in red or in the color specified for Active Objects in the DISPLAY folder. See To change display preferences.
- To remove the assignment, repeat the step above using instead, the right mouse button.
- Repeat the steps above for each assignment.

Solving the Model

Once the model has been completed, the user can proceed to solve it. Solving the model is done in two steps. The first is the finite element analysis. In the second step, the program calculates the required area of steel for the plate and the stiffener elements.

- From the menu on the left, choose **Solve** to have the program surface the SOLVE window shown below...

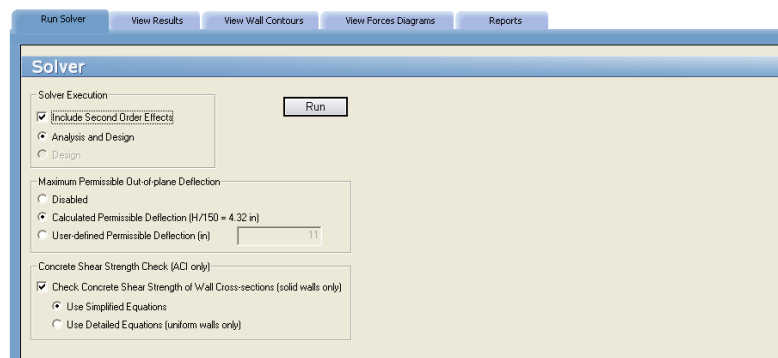

Alternatively, you could have **clicked** on the  button located on the TOOLBAR.

- Select the INCLUDE SECOND ORDER EFFECTS option to have the program perform second order analysis in which the out-of-plane (bending) action is magnified according to the values of the in plane forces and the out-of-plane deflections. When the checkbox is unchecked, the program performs first order analysis. See the discussion in Chapter 2.
- Select ANALYSIS AND DESIGN radio button to run both finite element analysis and design. If only the design portion of the solution needs to be re-run – e.g. due to a change in input that affects design only such as definition of reinforcing steel or design criteria – then the DESIGN option maybe selected. The program will run the design procedures without re-invoking the finite element solution which may be time consuming for larger models with many load combinations.
- Select an option to check displacement calculated for service load combinations against a maximum permissible out-of-plane displacement. There are three options available:
 - DISABLED: No displacement check is performed

- **CALCULATED PERMISSIBLE DEFLECTION:** Service load combinations out-of-plane displacements are checked against permissible deflection calculated by the program as $H/150$, where H is the overall height of the wall. The H value is used instead of length between supports (ℓ_c or ℓ) because values of ℓ_c (or ℓ) cannot be accurately determined by the program due to arbitrary wall geometries and support conditions available in the program. If approximation with H is not acceptable then the user can specify the exact value of the permissible deflection using the user-defined option described below.
- **USER-DEFINED PERMISSIBLE DEFLECTION:** Service load combinations out-of-plane displacements are checked against permissible deflection specified by the user. Displacements that exceed the permissible value are flagged in the results report.
- Select an option for checking shear strength of wall cross-sections provided by concrete. These options are only available for ACI and only for solid walls, i.e. walls without openings. Refer to Wall Shear Strength section in Chapter 2 of the manual for more information.
- Click on the RUN button.
- The input is first verified for any inconsistencies or errors. If there is data missing or still required, a message box will be displayed.
- The program then switches control to the solver module. The user should click SOLVE button in order to start the finite element analysis. A message box reporting the progress and status of the solution is displayed...

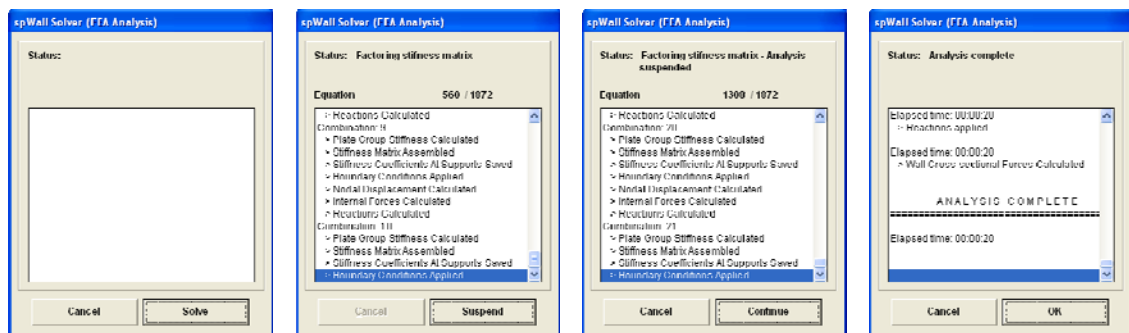

- Clicking the CANCEL button will cause the program to abort the solving procedure. At anytime during the solution process the computation may be stopped by clicking the SUSPEND button and then it can be either cancelled or resumed.
- When the analysis is successfully completed, click the OK button on the spWall Solver window to start the Design...

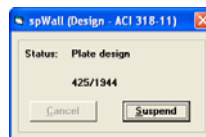

- After the design is successfully completed, results report showing displacement results is displayed. All results in text mode may be viewed using the **Solve / View Results** command and printed using the **File / Print Results** command. Graphical results may be viewed using the **Solve / View Wall Contours** or **Solve / View Forces Diagrams** command and printed using **File / Print Screen** command.

Viewing Results

After a successful run, the output may viewed be in tabular form using the **Solve / View Results** command.

- From the Solve menu, choose View Results to have the program surface the VIEW RESULTS folder as illustrated here...

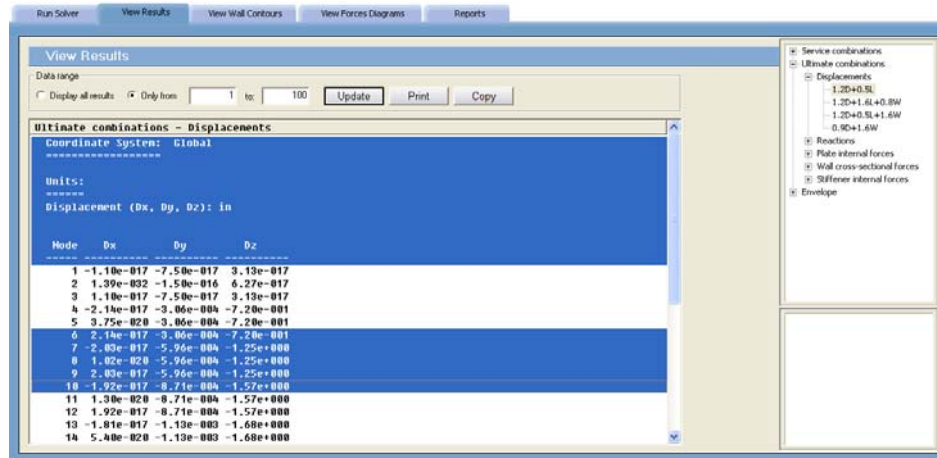

Alternatively, you could have clicked on the **Solve** button located on the toolbar, and then on the VIEW RESULTS tab.

Results may be selected by holding the Ctrl or Shift key and clicking on the lines in the main window. Press the PRINT button to print the selected lines, or press the COPY button to copy the selected lines to clipboard. If no lines are selected, all the currently displayed results in the main window will be printed or copied.

- The results are categorized into three types:

- **Service Combination:**

- **Displacements**

The displacements (D_x , D_y , and D_z) at each node are displayed due the selected service load combination. Displacements are shown in the directions of the global axes.

- **Reactions**

The forces and moments at each restrained node are displayed due the selected service load combination. Forces and moments are shown in the directions of the global axes. The program also reports sum of forces and moments (with respect to wall center of gravity) for applied reactions and loads.

- **Plate internal forces**

The in-plane forces (N_{xx} , N_{yy} , and N_{xy}), the bending moments (M_{xx} , M_{yy}) and the torsional moment (M_{xy}) in each plate element are displayed due the selected service load combination. Forces and moments are shown in the directions of the global axes, however, note that unlike in beams and columns, the traditional plate and shell theory convention is that M_{xx} denotes the moment along (not about) the X-axis and M_{yy} denotes the moment along the Y-axis. See Element Design Forces in Chapter 2 of the manual for the sign convention.

- **Stiffener internal forces**

The internal forces (N , V_y , and V_z), the internal bending moments (M_z , M_y) and the torsional moment (M_x) in each stiffener element are displayed due the selected service load combination. Forces and moments are shown in the directions of the local axes of the stiffener element. See Element Design Forces in Chapter 2 of the manual for the sign convention.

- **Ultimate Combination:**

- **Displacements**

The displacements (D_x , D_y , and D_z) at each node are displayed due the selected ultimate load combination. Displacements are shown in the directions of the global axes.

- **Reactions**

The forces and moments at each restrained node are displayed due the selected ultimate load combination. Forces and moments are shown in the directions of the global axes. The program also reports sum of forces and moments (with respect to wall center of gravity) for applied reactions and loads.

- **Plate internal forces**

The in-plane forces (N_{xx} , N_{yy} , and N_{xy}), the bending moments (M_{xx} , M_{yy}) and the torsional moment (M_{xy}) in each plate element are displayed due the selected ultimate load combination. Forces and moments are shown in the directions of

the global axes, however, note that unlike in beams and columns, the traditional plate and shell theory convention is that M_{xx} denotes the moment along (not about) the X-axis and M_{yy} denotes the moment along the Y-axis. See Element Design Forces in Chapter 2 of the manual for the sign convention.

- **Wall cross-sectional forces**
The cross-sectional forces (N_{uy} , V_{ux} , and V_{uz}) and moments (M_{ux} , M_{uy} , and M_{uz}) at wall sections directly above and directly below each horizontal grid line are displayed. The forces and moments are calculated with respect to centroid of the section based on loads and reactions for the selected ultimate load combination. Forces and moments are shown in the directions of the global axes and are subdivided into in-plane and out-plane categories. Only forces transferred by plate elements are considered, i.e. if a wall section intersects stiffeners then forces transferred by stiffeners are excluded and reported separately as stiffener internal forces.
- **Stiffener internal forces**
The internal forces (N , V_y and V_z), the internal bending moments (M_z , M_y) and the torsional moment (M_x) in each stiffener element are displayed due the selected ultimate load combination. Forces and moments are shown in the directions of the local axes of the stiffener element. See Element Design Forces in Chapter 2 of the manual for the sign convention.
- **Envelopes**
 - **Service displacements**
The maximum positive (+ve) and maximum negative (-ve) displacements (D_x , D_y , and D_z) at each node are displayed. Displacement envelopes are calculated from the results of the service load combinations. Displacements are shown in the directions of the global axes.
 - **Plate reinforcement**
The required areas of steel, in the X and the Y direction, in each plate element are reported. Half of the reported value applies to each curtain in models with two curtain layout. The results also show, the critical ultimate load combination that produces the smallest safety factor as well as the plate element design forces calculated for the critical load combination. See Chapter 2 for discussion about calculating the design forces in plate elements.
 - **Wall concrete shear strength**
This portion of results is only available for solid walls designed in accordance with the ACI codes and when the user selects the option to check concrete shear strength. Shear strength of wall cross sections directly above and directly below each horizontal grid line is reported for in-plane and out-of-plane directions. Shear strength provided by concrete is compared to the corresponding shear force for the load combination which results in the smallest safety factor.
 - **Stiffener flexural reinforcement**
The portion of the longitudinal area of steel that resists flexure is reported for each stiffener element. The results also show, the critical ultimate load combination that produces the smallest safety factor as well as the stiffener element design forces calculated for the critical load combination.
 - **Stiffener shear reinforcement**
The total transverse reinforcement required to resist both shear and torsion is reported for each stiffener element. The results are shown for the y and z directions that are the local axes of the stiffener element. The results also show, the critical ultimate load combination that produces the smallest safety factor as well as the stiffener element design forces calculated for the critical load combination.
 - **Stiffener torsion reinforcement**
The transverse and longitudinal reinforcement required to resist torsion only are reported for each stiffener element. The results also show, the critical ultimate load combination that produces the smallest safety factor as well as the stiffener element design forces calculated for the critical load combination.
 - **Stiffener reinforcement summary**
A summary of required transverse and longitudinal reinforcement are reported for each stiffener element.

Viewing Contours

After a successful run, the output may be viewed graphically as contours using the **Solve / View Wall Contours** command. If the design parameter assigned to an element is unattainable the program will display all contours as normal except the reinforcement contours which will show the failed element in grey and blue stripes.

- From the **Solve** menu, choose **View Wall Contours** to have the program surface VIEW WALL CONTOURS folder as illustrated below...

- Alternatively, you could have clicked on the **Solve** button located on the toolbar, and then on the **VIEW CONTOURS** tab.

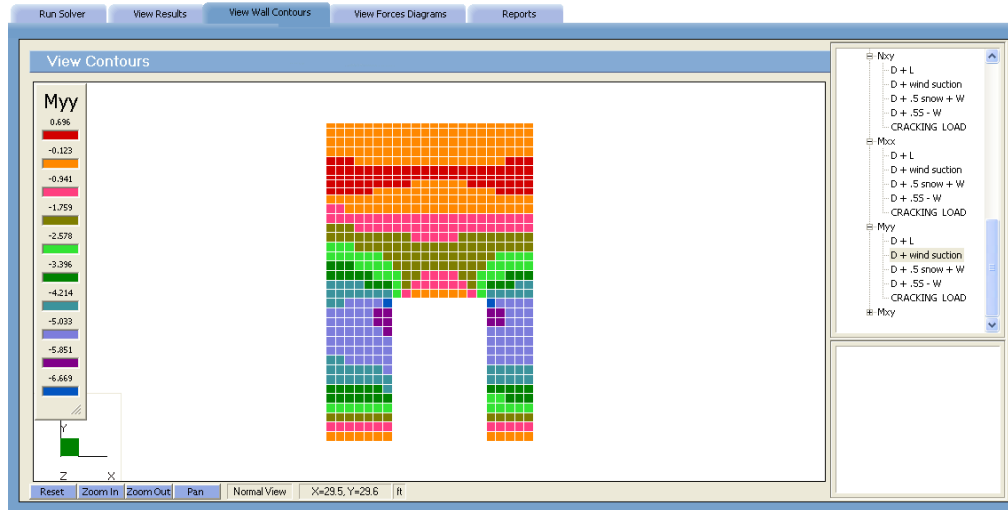

- The results are categorized into three types:
 - Envelopes
 - Service displacements

Contours for the maximum positive (+ve) and maximum negative (-ve) displacements (D_x , D_y and D_z) at each node are displayed. Displacement envelopes are calculated from the results of the service load combinations. Displacements are shown in the directions of the global axes.
 - Plate reinforcement

Contours for the required areas of steel for flexure in the X and the Y directions for each plate element are displayed. Half of the displayed value applies to each curtain in models with two curtain layout.
 - Service Combinations
 - Displacements

The displacements (D_x , D_y and D_z) at each node are displayed due the selected service load combination. Displacements are shown in the directions of the global axes.
 - Ultimate Combinations
 - Displacements

The displacements (D_x , D_y and D_z) at each node are displayed due the selected ultimate load combination. Displacements are shown in the directions of the global axes.
 - Plate internal forces

The in-plane forces (N_{xx} , N_{yy} , N_{xy}), the bending moments (M_{xx} , M_{yy}) and the torsional moment (M_{xy}) in each plate element are displayed due the selected ultimate load combination. Forces and moments are shown in the directions of the global axes.
- To print the displayed contours, choose the **File / Print Screen** command.
- Using the left-mouse button, marquee select the portion of the graphical image you wish to enlarge. The selected area is enlarged to occupy the entire GRAPHICS / INPUT AREA.

When flexure design of some elements fails and the user wants to display a contour map with plate flexural reinforcement, the program will display a warning message indicating that some elements failed flexure design and then the contour map will be shown. Elements that failed the design are marked with the color assigned to plate element in **Options / Display Preferences** and a diagonal pattern as illustrated here...

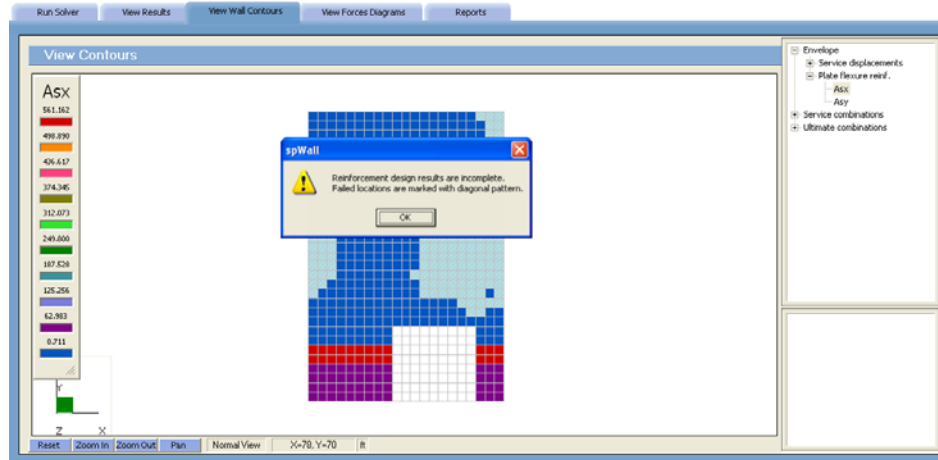

Viewing Diagrams

After a successful run, some result items related to stiffener elements may be viewed graphically as diagrams using the **Solve / View Forces Diagrams** command.

- From the **Solve** menu, choose **View Forces Diagrams** to have the program surface the VIEW DIAGRAMS folder as illustrated here...

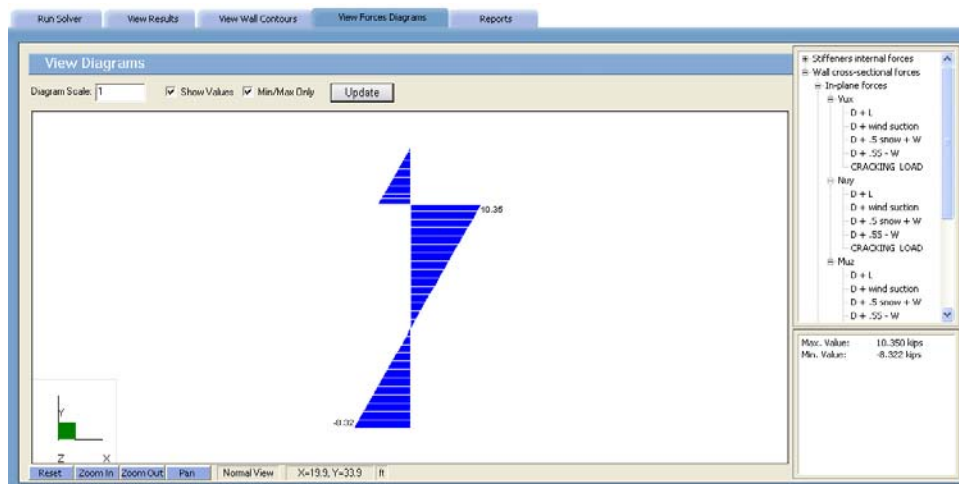

Alternatively, you could have clicked on the **Solve** button located on the toolbar, and then on the VIEW DIAGRAMS tab.

- The results are available for one category only:

- Ultimate Combinations

- Stiffener internal forces

The internal forces (N , V_y and V_z), the internal bending moments (M_z , M_y) and the torsional moment (M_x) in each stiffener element are displayed due the selected ultimate load combination. Forces and moments are shown in the directions of the local axes of the stiffener element. See the definition of stiffener local axes in Chapter 2.

- Wall cross-sectional forces

Diagrams of wall cross-sectional forces (N_{wy} , V_{ux} and V_{uz}) and moments (M_{ux} , M_{uy} , and M_{uz}) at horizontal sections along the wall height are displayed. The forces and moments are calculated with respect to centroid of the section based on loads and reactions for the selected ultimate load combination. Forces and moments are shown in the directions of the global axes.

- Wall concrete shear strength

This portion of results is only available for solid walls designed in accordance with the ACI codes and when the user selects the option to check concrete shear strength. Diagrams of shear strength of horizontal cross sections along wall height are displayed for in-plane and out-of-plane directions. Shear strength provided by concrete is calculated for the load combination which results in the smallest safety factor when compared to the corresponding shear force.

- To print the displayed diagrams, choose the **File / Print Screen** command.
- Using the left-mouse button, marquee select the portion of the graphical image you wish to enlarge. The selected area is enlarged to occupy the entire GRAPHICS / INPUT AREA.

Defining Options

There are many options that can be set as default so that they are saved to be applied to any subsequent project until they are changed again.

From the **Options** menu, choose **Startup Defaults**, **Autosave** or **Display** to have the program surface the respective OPTION folder as illustrated here.

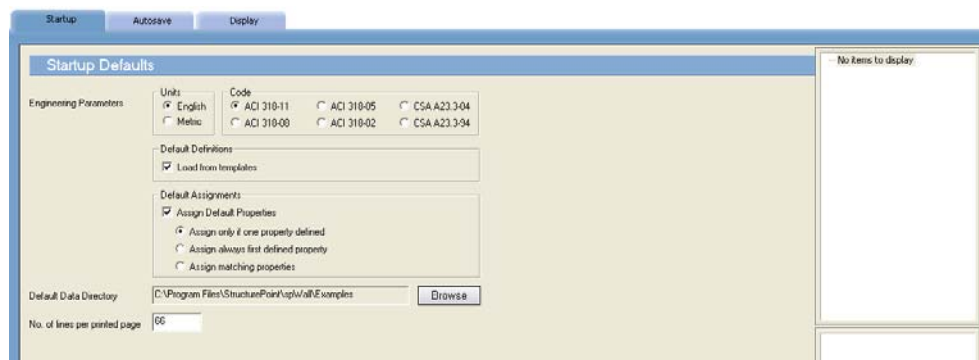

Alternatively, you could have clicked on the **Options** button located on the toolbar.

To Define Startup Defaults:

The **Options / Startup Defaults** command is used to save the current file settings to be used in future input sessions. Default settings are saved in the Windows registry file. Settings that are saved include units of measure, code, and default directories.

- With the **STARTUP** folder surfaced, from the **UNITS** options group, choose the applicable units of measure and from the **CODE** options group, select the appropriate design code.
- Select the **DEFAULT DEFINITIONS / LOAD FROM TEMPLATES** option which provides default definitions and load combinations in the define window to facilitate creation of new models. The values of the parameters will depend on the code and the unit system selected in the **STARTUP DEFAULTS** window. If the option is enabled then the newly created data file will by default contain predefined values stored in template files located in **Templates** subfolder of the **spWall** program folder (e.g. "c:\Program Files\StructurePoint\spWall\Templates"). The user may open the template files and modify them as regular **spWall** files in order to customize the default values to the user's needs.
- Check the **ASSIGN DEFAULT PROPERTIES** if – at the time of assigning thickness to an element in the model – you want the program to automatically assign properties from remaining and unassigned categories based on one of the three following options.
 - **ASSIGN ONLY IF ONE PROPERTY DEFINED** will assign other properties to the element of defined thickness if they are the only definitions within their property category.
 - **ASSIGN ALWAYS FIRST DEFINED PROPERTY** will assign the first properties from each category to the element of defined thickness.
 - **ASSIGN MATCHING PROPERTIES** will assign properties whose positions within their respective categories are the same as the position of the thickness being assigned.

Once the automatic assignment has been made the user can manually reassign the properties.

- Specify a default data directory. The path you specify here is where any data files you save will be saved by default. Note, however, that you will still be able to specify a different location when you attempt to save. See *Saving the Data*.
- You may also control the number of lines printed per page.

To Control the Autosave Feature:

The **Options / Autosave** command is used to force the program to save your input data to disk at predefined intervals. This minimizes loss of data in case of a power loss or computer lock-up. Note that the file must be named (using the **File / Save As** command) prior to activating this feature.

- With the AUTOSAVE folder surfaced, place a checkmark in the ENABLE AUTOSAVE box to activate the auto save feature.
- In the FREQUENCY text box, specify the time interval that you would like the program to run the autosave feature.

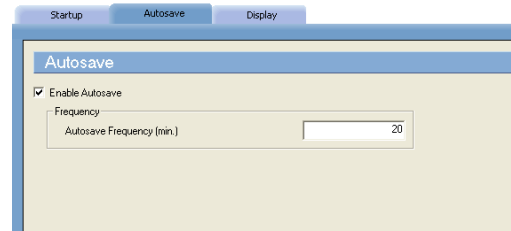

To Customize Display Settings:

The **Options / Display** command is used to change the color settings of the graphical image to those of personal preference.

- Within the FONT group, click on the CHOOSE FONT button to select the font type and size that will be used in plotting the node and element numbers on the graphical display. The font types that appear in the list are those saved in your WINDOWS/FONTS directory. The font you specify here is also used in screen-printing.
- Use the color drop-down lists within the OBJECT COLOR group to select preferred colors for the following...
 - Grid
 - Active (object, node or element)
 - Inactive (object, node or element)
 - Plate elements (without an assignment)
 - Stiffeners (without an assignment)
 - Background
 - Diagram
- Click the DEFAULT COLORS button to change colors back to their default settings.
- In the Display Preference group, the user can modify the following...
 - SHOW NODE LABELS AS: numbers or coordinates
 - SHOW NODE LABELS FOR: nodes all nodes or selectively for wall and stiffener nodes or for nodes with assigned loads or restrains.
 - SHOW ELEMENT LABELS – toggles the display of element numbers for wall and stiffener elements
 - SHOW DIAGRAM VALUES – toggles the display of values in forces diagrams
 - GRID LINE TYPE – selects the style of the grid line, SOLID or DOTTED

- **COORDINATE PRECISION** – specifies the precision of the cursor location displayed in the STATUS BAR.

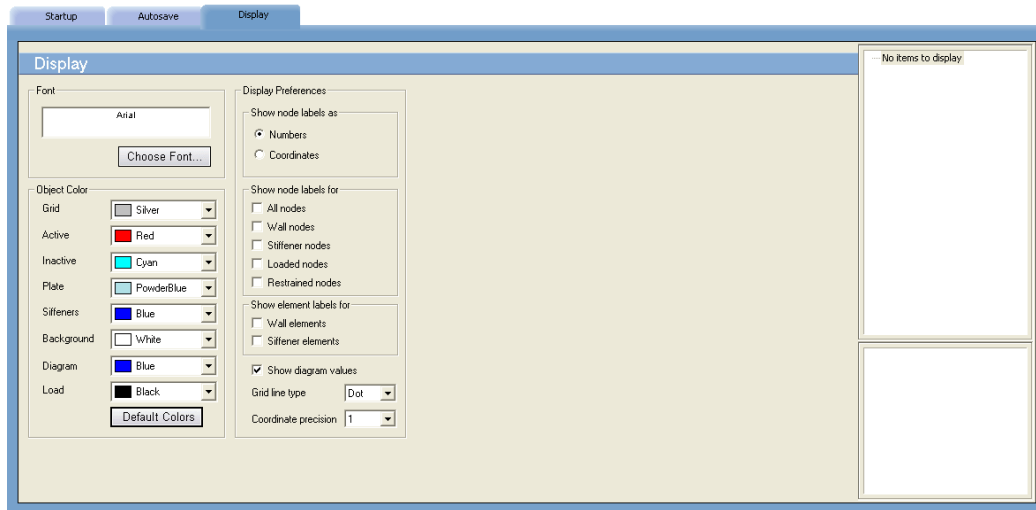

Example 1

Problem Formulation

Design of the wall shown below is required. Second order analysis will be performed. This example is based on Example 21.1 in Reference 1.

Design Data:

Concrete: $f'_c = 4.0$ ksi, $w_c = 150$ pcf, $\nu = 0.15$.

Reinforcing steel: $f_y = 60.0$ ksi, $E_s = 29,000$ ksi.

Wall thickness = 6.5 in.

Eccentricity (e) = 6.75 in.

Roof dead load = 1.60 klf (line load)

Roof live load = 0.64 klf (line load)

Wind load = 20.0 psf (uniform area load)

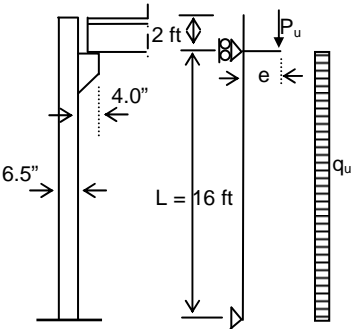

Reinforcement is considered as one curtain composed of two layers (one horizontal and one vertical) located in the middle of wall thickness.

It is assumed that the wall acts as a one-way system in the Y-direction. Therefore, a strip of 1 ft width is modeled. The origin of the XY plane will be located at the lower left-hand corner of the wall. One-foot square elements will be used; thus, the grid system consists of two grid lines, one foot apart, in the X-direction and 19 grid lines in the Y-direction.

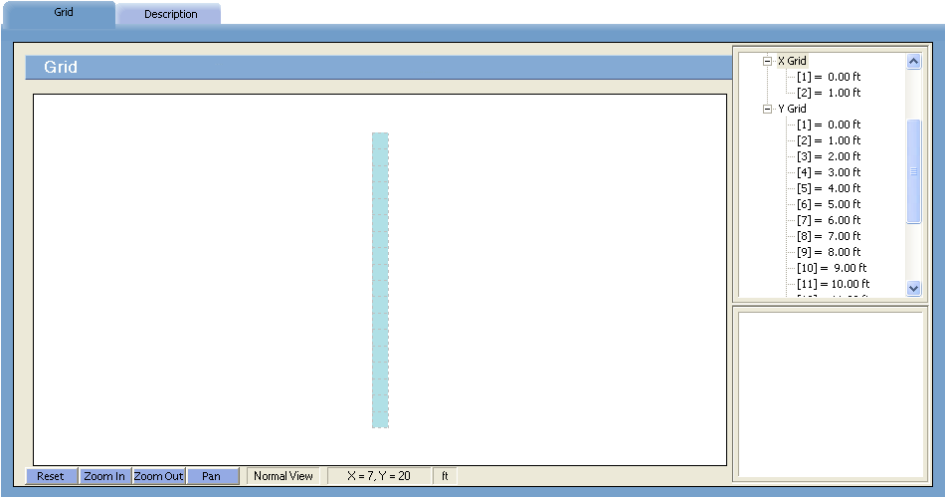

Preparing the Input

1. From the **Define** menu, select **Project description** to surface the DESCRIPTION folder...

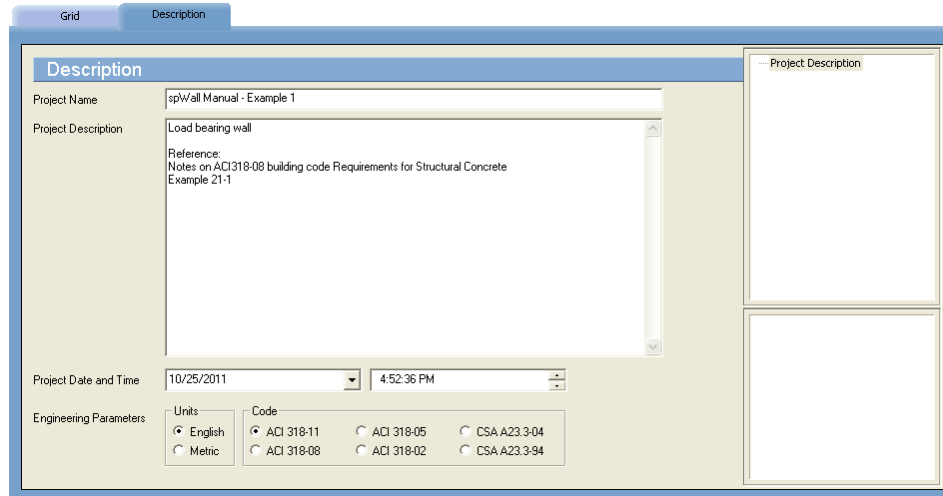

- Input the project information and select ENGLISH units along with the ACI code. Notice how the current date and time is displayed by default.
2. From the **Define** menu, select **Grid**, or simply click on the tab to surface the respective folder...

Since the grid layout is uniform, and symmetrical in both directions, X and Y grid lines will be generated.

- Double-click on the GENERATE option in the ITEM LISTING AREA to have the program surface the following...

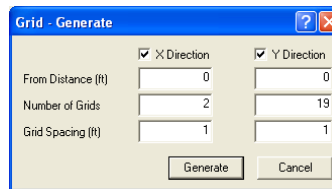

- Place a check mark in the X- DIRECTION box and enter the following values in the corresponding text boxes...

FROM DISTANCE:	0
NUMBER OF GRIDS:	2
GRID SPACING:	1
 - Place a check mark in the Y- DIRECTION box and enter the following values in the corresponding text boxes...

FROM DISTANCE:	0
NUMBER OF GRIDS:	19
GRID SPACING:	1
 - Click on the GENERATE button to return focus to the GRID folder. Notice how the X and Y grid lines now appear in the GRAPHICS/INPUT AREA.
3. From the **Define** menu, choose **Properties** to surface the PROPERTIES folder...

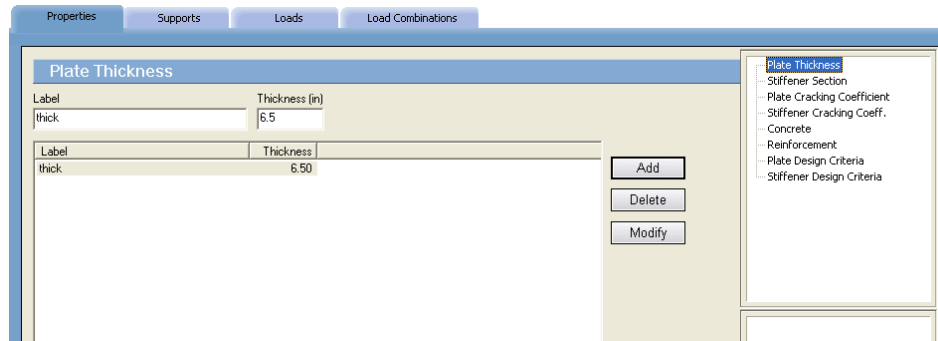

- Input Thick for LABEL and 6.5 for THICKNESS.
 - Click on the ADD button to add the entry to the list
4. Click on the PLATE CRACKING COEFFICIENT option in the ITEM LISTING AREA to have the program surface the respective folder.
- Enter the following...

LABEL:	Cracking
SERVICE COMBINATIONS:	
IN PLANE:	1.0
OUT OF PLANE:	1.0
ULTIMATE COMBINATIONS:	
IN PLANE:	1.0
OUT OF PLANE:	0.079
 - Click on the ADD button to add the entry to the list.
5. Click on the CONCRETE option in the ITEM LISTING AREA to have the program surface the respective folder.
- Enter the following...

LABEL:	Conc
UNIT WEIGHT:	150 pcf
COMPRESSIVE STRENGTH:	4 ksi
YOUNG'S MODULUS:	3834.25 ksi
POISSON'S RATIO:	0.15
 - Click on the ADD button to add the entry to the list.
6. Click on the REINFORCEMENT option in the ITEM LISTING AREA to have the program surface the respective folder.
- Enter the following...

LABEL:	Steel
YIELD STRENGTH:	60 ksi
YOUNG'S MODULUS:	29000 ksi
 - Click on the ADD button to add the entry to the list.
7. Click on the PLATE DESIGN CRITERIA option in the ITEM LISTING AREA to have the program surface the respective folder.
- Enter the following...

LABEL: DC1
 REINFORCEMENT LAYOUT: ONE CURTAIN
 REINFORCEMENT RATIO:
 HORIZONTAL MIN.: .2%
 HORIZONTAL MAX. : 8%
 VERTICAL MIN.: .256%
 VERTICAL MAX. : 8%
 REINFORCEMENT LOCATION:
 CURTAIN 1 HORIZONTAL: 3.25 in
 CURTAIN 1 VERTICAL: 3.25 in

- Click on the ADD button to add the entry to the list.
8. From the **Define** menu, select **Supports**, or simply click on the  tab to surface the respective folder²⁴. Click RIGID SUPPORTS from the ITEM LISTING AREA

- Enter the following...

LABEL: Simple

- Select the following restraints to model simply supported end conditions: Dx, Dy, and Dz.
- Click on the ADD button to add the entry to the list.
- Enter the following...

LABEL: Roller

- Select the following restraints to model roller end conditions: Dz.
- Click on the ADD button to add the entry to the list.

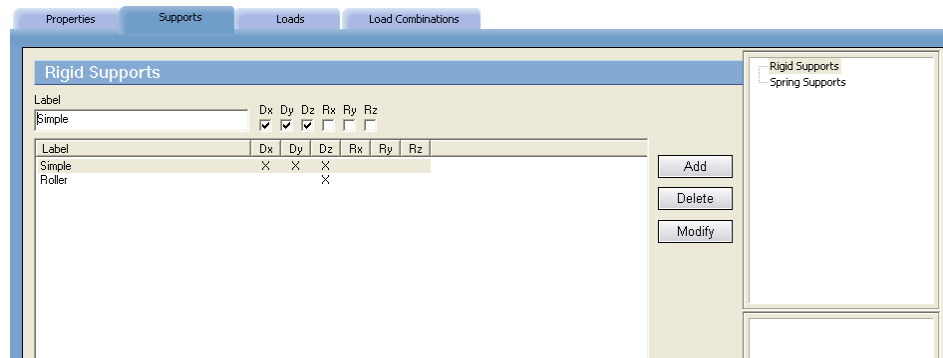

9. From the **Define** menu, select **Loads**, or simply click on the  tab to surface the respective folder...Click UNIFORM LINE LOAD from the ITEM LISTING AREA

- Enter the following

LOAD CASE: A

²⁴ For simplicity, only external boundary conditions are modeled in this example. Additionally, symmetry end conditions could be applied to account for the fact that the one foot wide strip under consideration is a part of a larger wall assumed to act as a one-way system in the vertical (Y) direction. This condition can be modeled by restraining Dx, Ry, and Rz degrees of freedom along the vertical edges of the strip to restrict horizontal displacement and to allow curvature deformation only in the vertical direction. In this example, however, the increased accuracy of modeling boundary conditions has only a minimal impact on the final results.

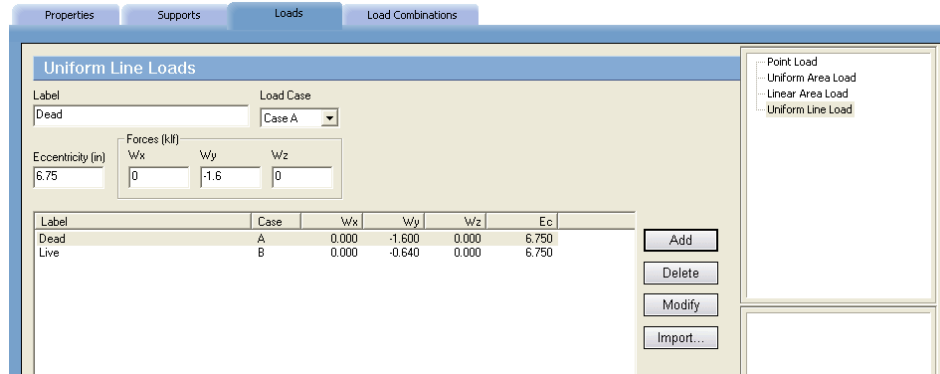

LABEL: Dead
 ECCENTRICITY: 6.75 in.
 WY: -1.6 klf (down)

- Click on the ADD button to add the entry to the list.
- Enter the following...

LOAD CASE: B
 LABEL: Live
 ECCENTRICITY: 6.75 in.
 WY: -0.64 klf (down)

- Click on the ADD button to add the entry to the list.

9. Click on the UNIFORM AREA LOAD option in the ITEM LISTING AREA to have the program surface the respective folder.

- Enter the following...

LOAD CASE: C
 LABEL: Wind
 WZ: -20 psf (into the XY plane)

- Click on the ADD button to add the entry to the list.

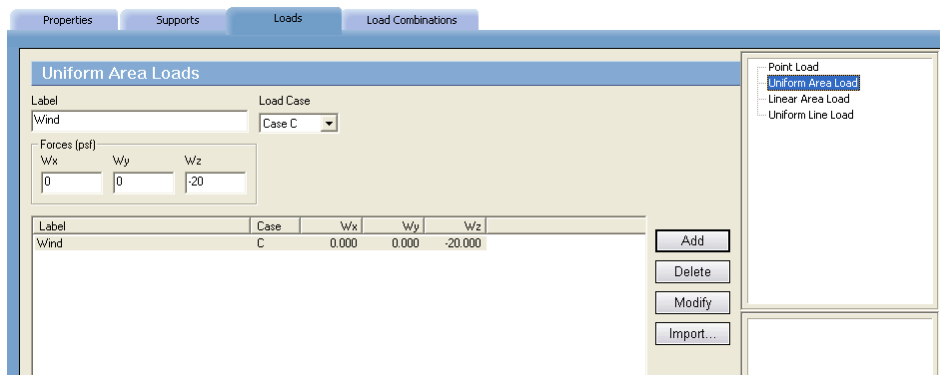

10. From the **Define** menu, choose **Load Combinations**, or simply click on the **Load Combinations** tab to surface the respective folder...

- Check INCLUDE SELF-WEIGHT WITH CASE A FOR ALL LOAD COMBINATIONS
- Enter the following

LABEL: S1
CASE A: 1.0
ALL OTHER CASES: 0.0

- Click on the ADD button to add the entry to the list.

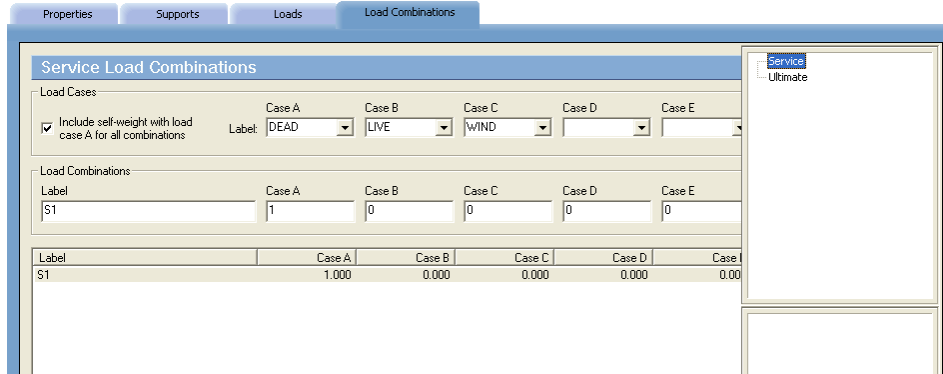

11. Click on the ULTIMATE option in the ITEM LISTING AREA to have the program surface the respective folder.

- Enter the following...

LABEL: 1.2D+0.5L
CASE A: 1.2
CASE B: 0.5
ALL OTHER CASES: 0.0

- Click on the ADD button to add the entry to the list.

- Enter the following...

LABEL: 1.2D+1.6L+0.8W
CASE A: 1.2
CASE B: 1.6
CASE C: 0.8
ALL OTHER CASES: 0.0

- Enter the following...

LABEL: 1.2D+0.5L+1.6W
CASE A: 1.2
CASE B: 0.5
CASE C: 1.6
ALL OTHER CASES: 0.0

- Click on the ADD button to add the entry to the list.

- Enter the following...

LABEL: 0.9D+1.6W
CASE A: 0.9
CASE C: 1.6

ALL OTHER CASES: 0.0

- Click on the ADD button to add the entry to the list.

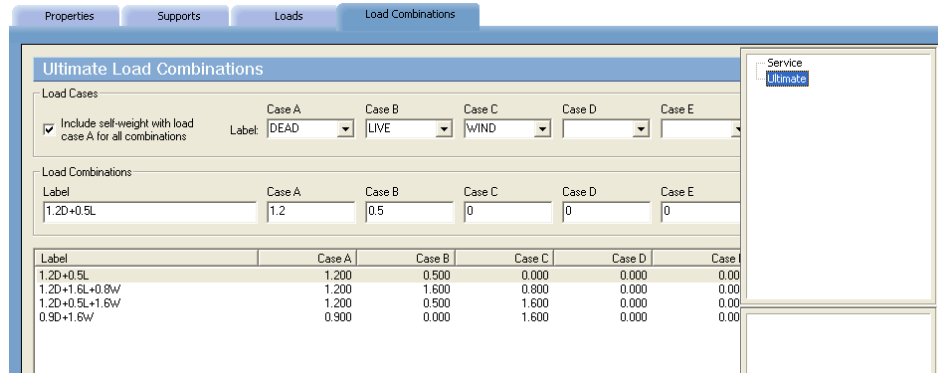

Assigning Properties

- From the **Assign** menu, select **Properties** to surface the respective folder.
 - From the ITEM LISTING AREA, select THICK.
 - In the GRAPHICS/INPUT AREA, marquee-select the region (-1, 19)-(2, -1) to apply the selected thickness to the entire wall. The selected plate elements are redrawn in red.

Note: To see the assigned element and node numbers, from the **Define** menu, select **Grid**, and once the GRID folder surfaces, double click on PREFERENCES.
- Click on the PLATE CRACKING COEFFICIENT option in the ITEM LISTING AREA.
 - From the ITEM LISTING AREA, select CRACKING.
 - In the GRAPHICS/INPUT AREA, marquee-select the region (-1, 19)-(2, -1) to apply the selected cracking coefficients to the entire wall. The selected plate elements are redrawn in red.
- Repeat the step above using the **Concrete**, **Reinforcement** and **Plate Design Criteria** commands to apply CONC, STEEL and DC1 properties to the entire wall.

Assigning Supports

- From the **Assign** menu, select **Supports** or simply click on the **Supports** tab to surface the respective folder.
 - In the Item LISTING AREA, expand RIGID SUPPORTS and select SIMPLE.
 - Marquee and apply SIMPLE supports to the bottom two nodes as shown in the figure below...

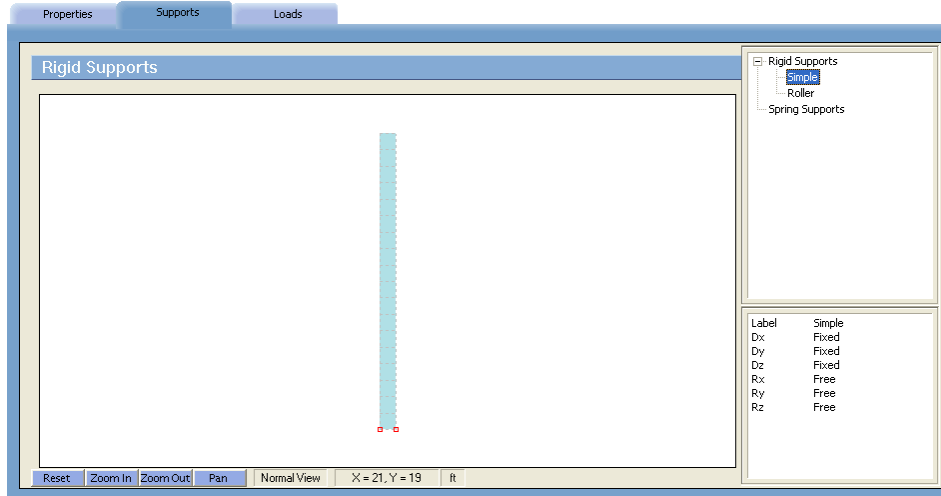

- In the Item LISTING AREA, select ROLLER rigid supports.
- Marquee and apply ROLLER supports to the bottom two nodes as shown in the figure below...

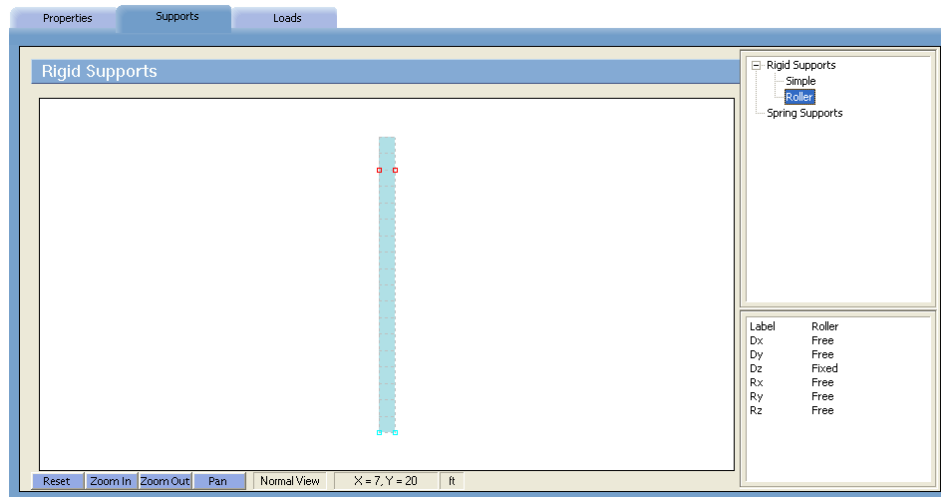

Assigning Loads

- From the **Assign** menu, select **Loads** or simply click on the **Loads** tab to surface the respective folder.
 - In the ITEM LISTING AREA, expand CASE A and then expand UNIFORM LINE LOADS to select DEAD.
 - Marquee and apply load as shown in the figure below...

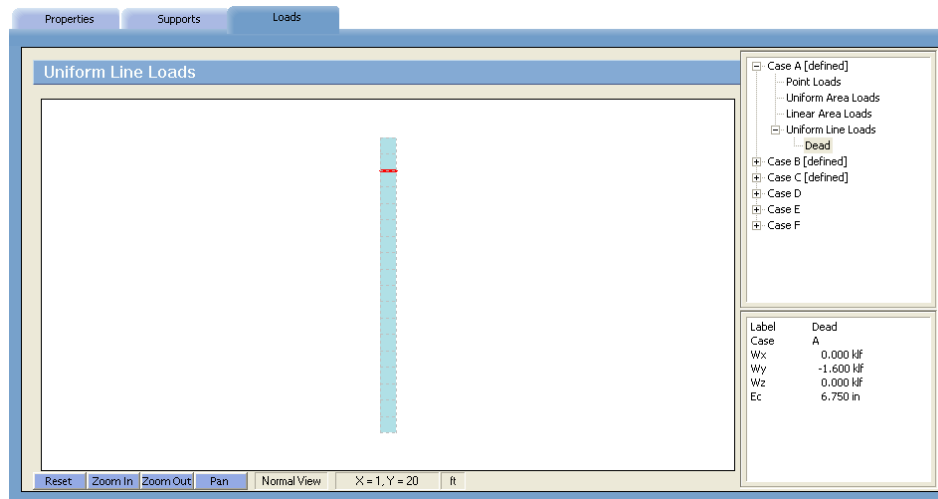

- In the ITEM LISTING AREA, expand CASE B and then expand UNIFORM LINE LOADS to select LIVE.
- Marquee and apply load.
- In the ITEM LISTING AREA, expand CASE C and then expand UNIFORM AREA LOADS to select WIND.
- Marquee and apply load as shown in the figure below...

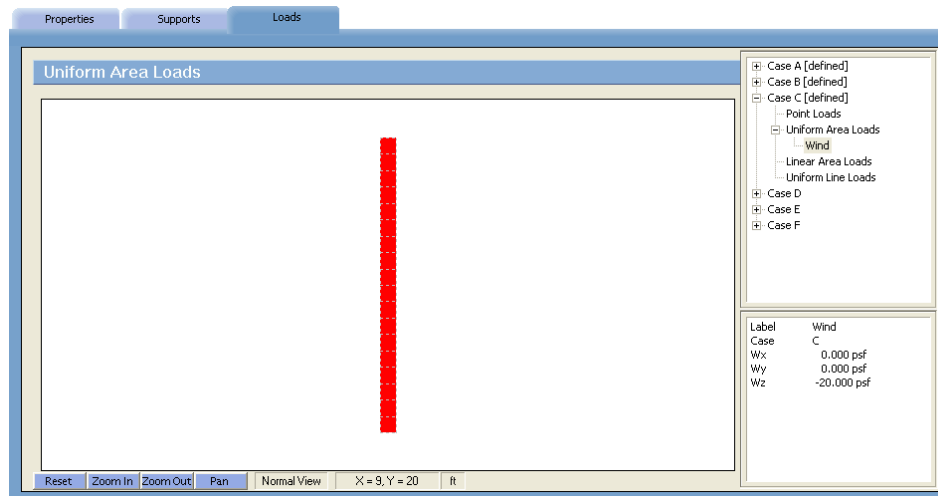

Solving

17. From the **Solve** menu, click **Execute** to surface the ANALYSIS dialog box...

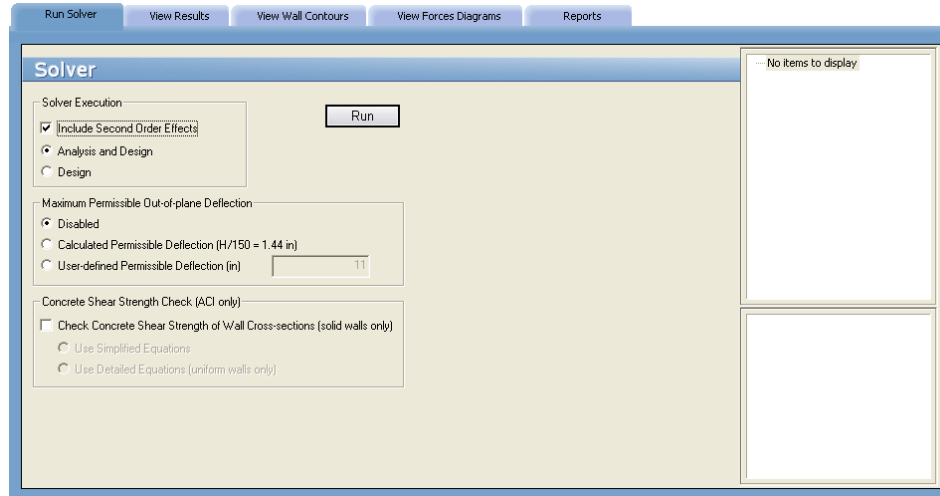

- Keep INCLUDE SECOND ORDER EFFECTS checked.
- Uncheck: CHECK CONCRETE SHEAR STRENGTH OF WALL CROSS-SECTIONS (SOLID WALLS ONLY)
- Disable: MAXIMUM PERMISSIBLE OUT-OF-PLANE DEFLECTION
- Click on the RUN button and then click on the SOLVE button.
- The spWall SOLVER window is displayed and the solver messages are listed. After the solution is done, the design will be performed and then the focus will immediately be passed to the VIEW RESULTS folder.

Viewing and Printing Results

18. After a successful run, view results in text format or forces diagrams by selecting an item from the ITEM LISTING AREA.

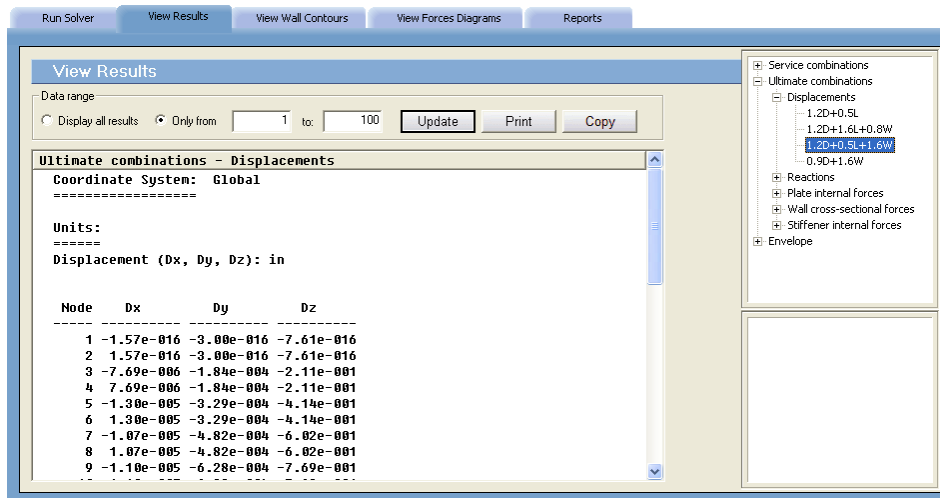

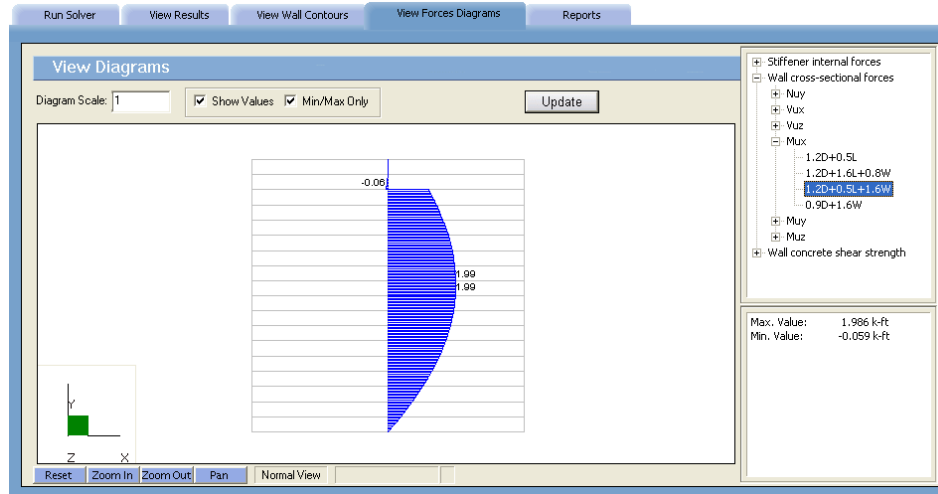

19. Results can be viewed in a contour form by selecting the VIEW CONTOUR folder.

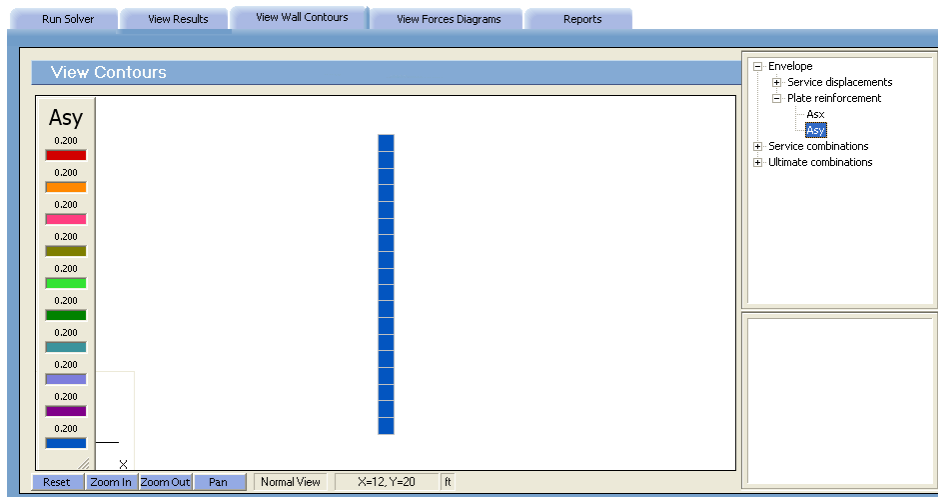
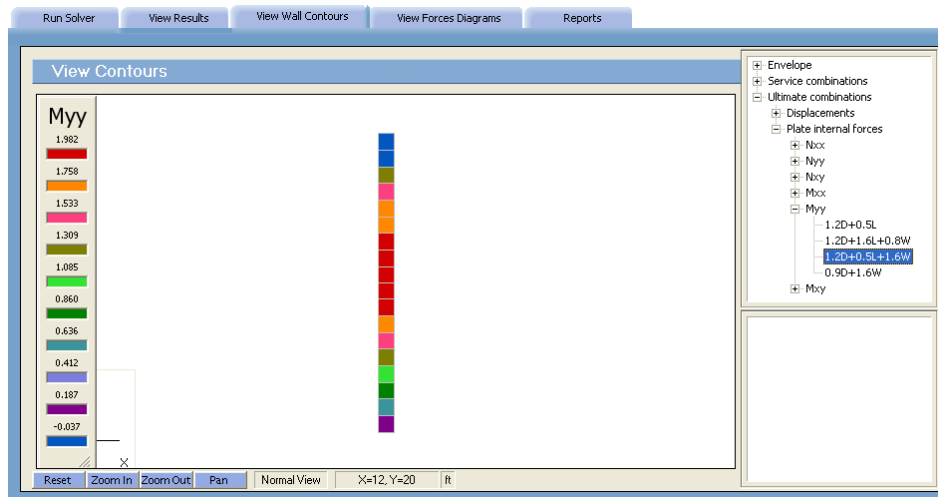

20. To print the contour, select menu **File/Print Screen**. To print the results, Select **REPORTS** tab and follow the instructions outlined in Chapter 4.

Example 2

Problem Formulation

Design the stem of the shown retaining wall. This example refers to Example 12.5 in Reference 2.

Design Data:

Concrete: $f'_c = 3.0$ ksi, $w_c = 150$ pcf,

Poisson's ratio = 0.15.

Reinforcing steel: $f_y = 40.0$ ksi, $E_s = 29,000.0$ ksi.

Wall thickness = 12 in. @ top of the wall

= 21 in. @ bottom of the wall

Lateral earth pressure:

Due to soil weight = 640 psf

Due to surcharge = 256 psf

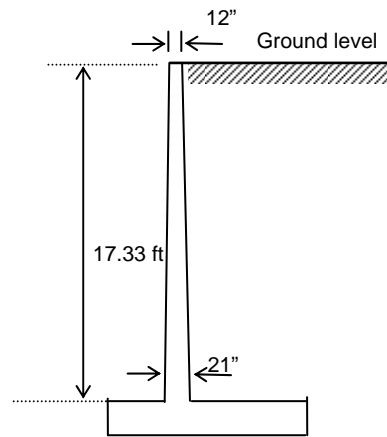

Fig. 5-2 a. Geometry

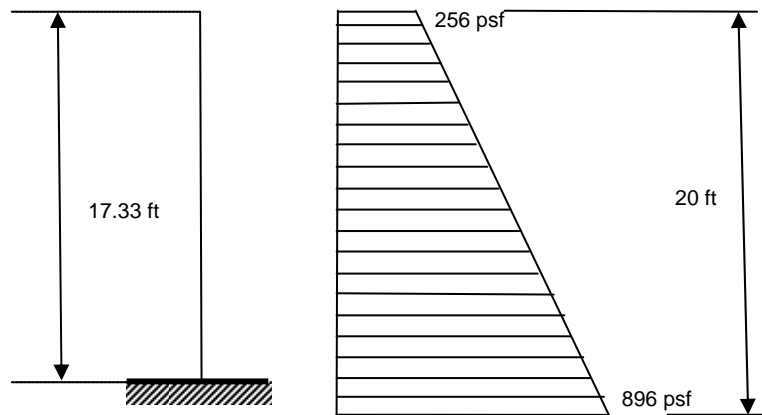

Figure 5-2 b Structural Model

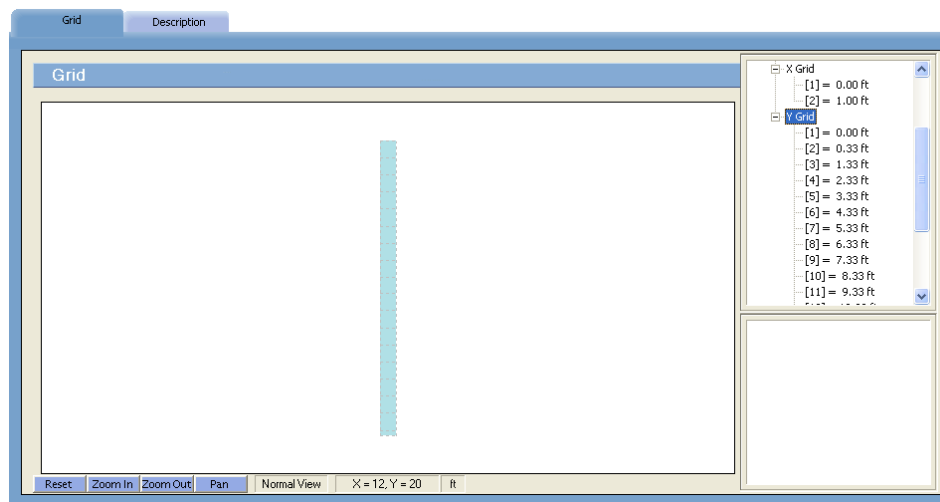
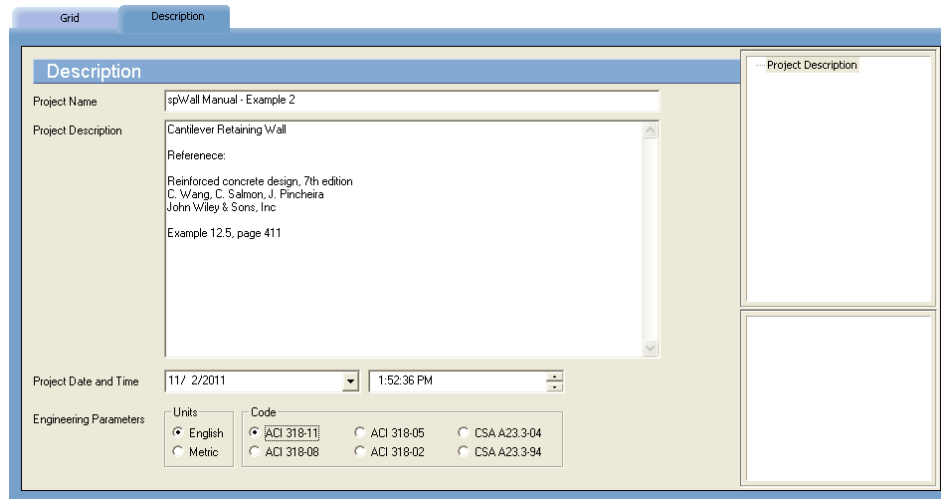

Figure 5-2 c Finite Element Mesh

It is assumed that the wall acts as a one-way system in the Y-direction. Therefore, strip of 1 ft width is modeled. The origin of the XY plane will be located at the lower left-hand corner of the wall. The grid system consists of two grid lines, one foot apart, in the X-direction and nineteen grid lines in the Y-direction.

Preparing the Input

- From the **Define** menu, select **Project description** to surface the DESCRIPTION folder...
 - Input the project information and select ENGLISH units along with the ACI code. Notice how the current date and time is displayed by default.



- Input the project information and select ENGLISH units along with the ACI code. Notice how the current date and time is displayed by default.
- From the **Define** menu, select **Grid**, or simply click on the **Grid** tab to surface the respective folder.
 - Double-click on the GENERATE option in the ITEM LISTING AREA to have the program surface the following...

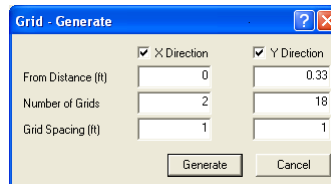

- Place a check mark in the X- DIRECTION box and enter the following values in the corresponding text boxes...

FROM DISTANCE:	0
NUMBER OF GRIDS:	2
GRID SPACING:	1
- Place a check mark in the Y- DIRECTION box and enter the following values in the corresponding text boxes...

FROM DISTANCE:	0.33
NUMBER OF GRIDS:	18
GRID SPACING:	1
- Click on the GENERATE button to return focus to the GRID folder. Notice how the X and Y grid lines now appear in the GRAPHICS/INPUT AREA.

5. Click on the REINFORCEMENT option in the ITEM LISTING AREA to have the program surface the respective folder.

- Enter the following...

LABEL: Steel
 YIELD STRENGTH: 40 ksi
 YOUNG'S MODULUS: 29000 ksi

- Click on the ADD button to add the entry to the list.

6. Click on the PLATE DESIGN CRITERIA option in the ITEM LISTING AREA to have the program surface the respective folder.

- Enter the following...

LABEL: DC1
 REINFORCEMENT LAYOUT: TWO CURTAINS
 REINFORCEMENT RATIO:
 HORIZONTAL MIN.: .2%
 HORIZONTAL MAX. : 8%
 VERTICAL MIN.: .12%
 VERTICAL MAX. : 8%
 REINFORCEMENT LOCATION:
 CURTAIN 1 HORIZONTAL: 3.00 in
 CURTAIN 1 VERTICAL: 2.50 in
 CURTAIN 2 HORIZONTAL: 2.00 in
 CURTAIN 2 VERTICAL: 2.50 in

- Click on the ADD button to add the entry to the list.

7. From the **Define** menu, select **Supports**, or simply click on the  tab to surface the respective folder²⁵. Click RIGID SUPPORTS from the ITEM LISTING AREA

- Enter the following

LABEL: Fixed

- Select all restraints to model fixed support end conditions.
- Click on the ADD button to add the entry to the list.

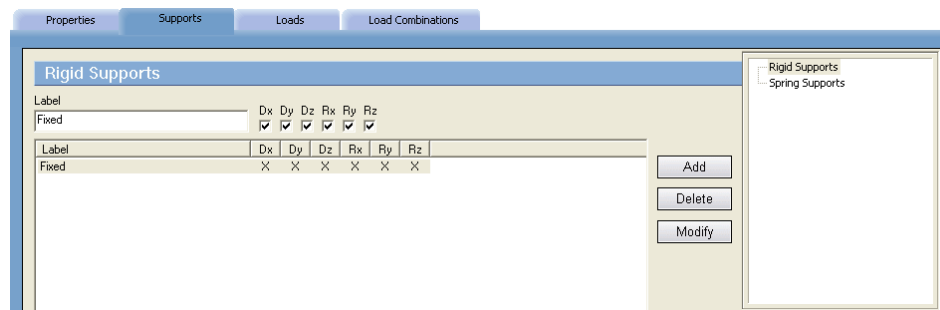

²⁵ For simplicity, only external boundary conditions are modeled in this example. Additionally, symmetry end conditions could be applied to account for the fact that the one foot wide strip under consideration is a part of a larger wall assumed to act as a one-way system in the vertical (Y) direction. This condition can be modeled by restraining Dx, Ry, and Rz degrees of freedom along the vertical edges of the strip to restrict horizontal displacement and to allow curvature deformation only in the vertical direction. In this example, however, the increased accuracy of modeling boundary conditions has only a minimal impact on the final results.

- Enter the following...

LABEL:	1.2D+1.6H
CASE A:	1.2
CASE B:	1.6
ALL OTHER CASES:	0.0
- Click on the ADD button to add the entry to the list.
- Enter the following...

LABEL:	0.9D+1.6H
CASE A:	0.9
CASE B:	1.6
ALL OTHER CASES:	0.0
- Click on the ADD button to add the entry to the list.

Assigning Properties

- From the **Assign** menu, select **Properties** to surface the respective folder.
 - From the ITEM LISTING AREA, expand PLATE THICKNESS and select t12.
 - In the GRAPHICS/INPUT AREA, marquee-select the region (-1, 18)-(2, 16) to apply the selected thickness to the top wall element. The selected plate elements are redrawn in red...

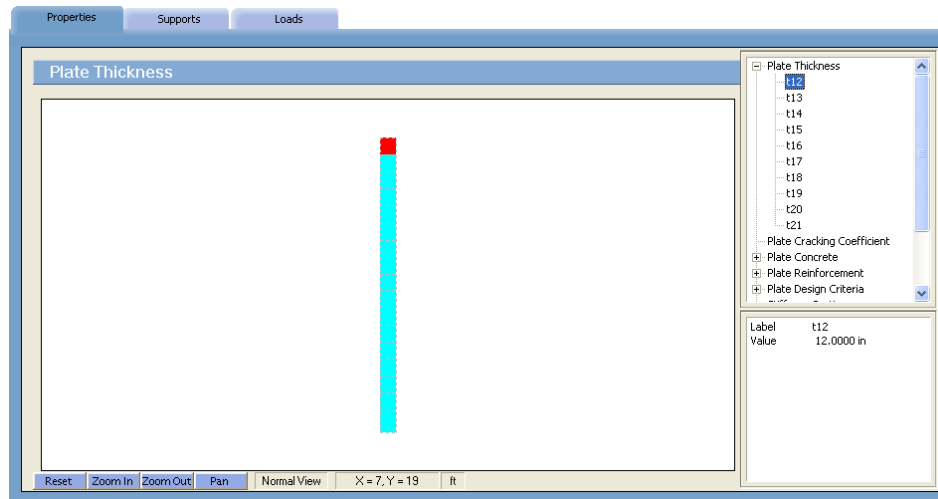

- From the ITEM LISTING AREA, expand PLATE THICKNESS and select t13.
- In the GRAPHICS/INPUT AREA, marquee-select the region (-1, 17)-(2, 14) to apply the selected thickness to the next two wall elements. The selected plate elements are redrawn in red.

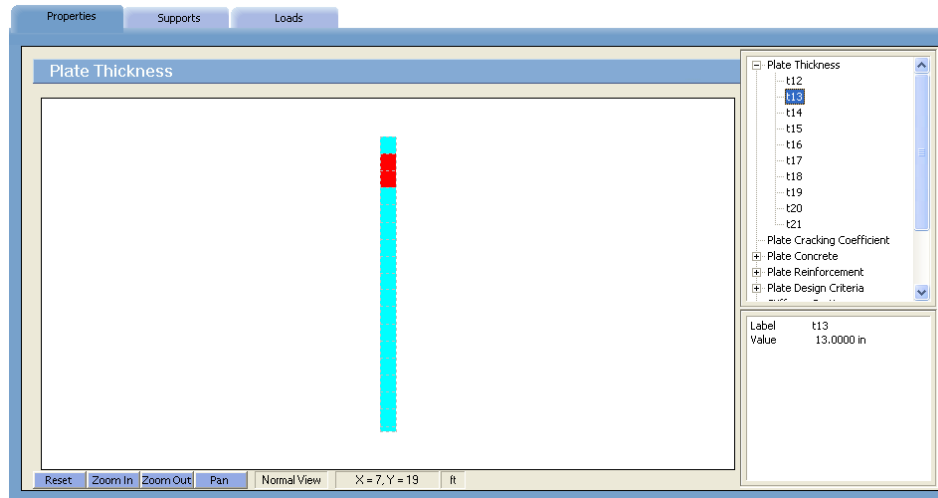

- Continue to apply different thicknesses to wall elements as described above, using two plate elements for each remaining thickness.
- The last remaining element at the bottom of the wall will be assigned with thickness t21.

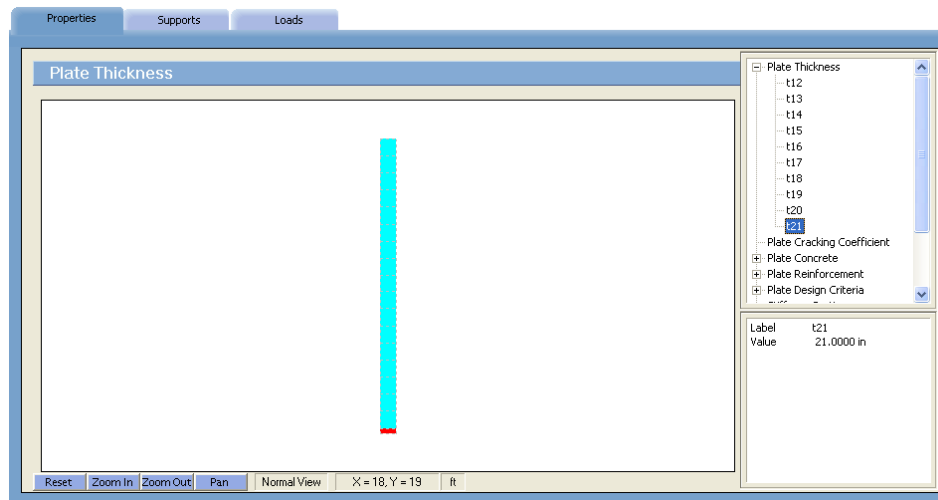

Note: The plate thickness of an element can also be assigned by selecting the desired thickness and then click on the individual plate elements. To see the assigned element and node numbers, from the **Define** menu, select GRID, and once the GRID folder surfaces, double click on PREFERENCES.

- From the ITEM LISTING AREA, expand PLATE CONCRETE and select CONC.
 - In the GRAPHICS/INPUT AREA, marquee-select the region (-1, 18)-(1, 0) to apply the selected concrete to the entire wall. The selected plate elements are redrawn in red
- Repeat the step above using the **Reinforcement** and **Plate Design Criteria** commands to apply STEEL and DC1 properties to the entire wall.

Assigning Supports

- From the **Assign** menu, select **Supports** or simply click on the tab to surface the respective folder.
 - In the ITEM LISTING AREA, expand RIGID SUPPORTS and select FIXED.
 - Marquee and apply FIXED supports to the bottom two nodes as shown in the figure below...

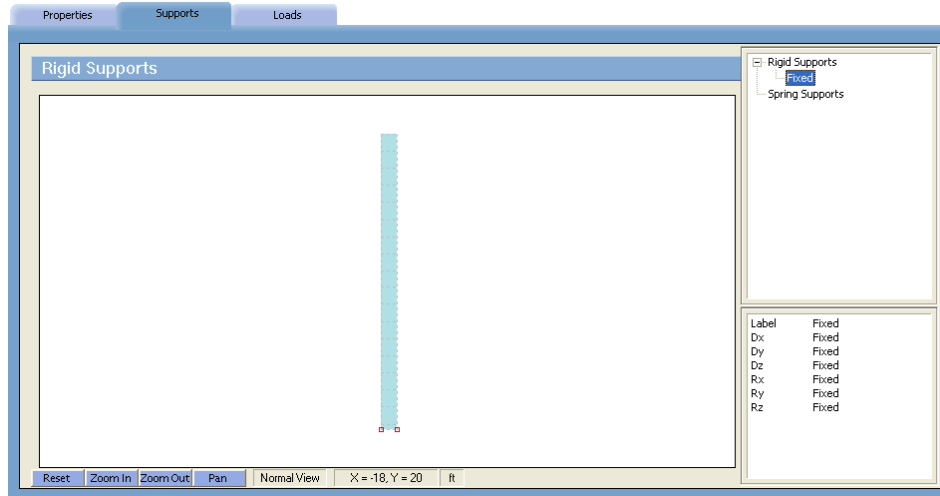

Assigning Loads

- From the **Assign** menu, select **Loads** or simply click on the **Loads** tab to surface the respective folder.
 - In the ITEM LISTING AREA, expand CASE B and then expand LINEAR AREA LOADS to select SOIL.
 - Marquee and apply load as shown in the figure below...

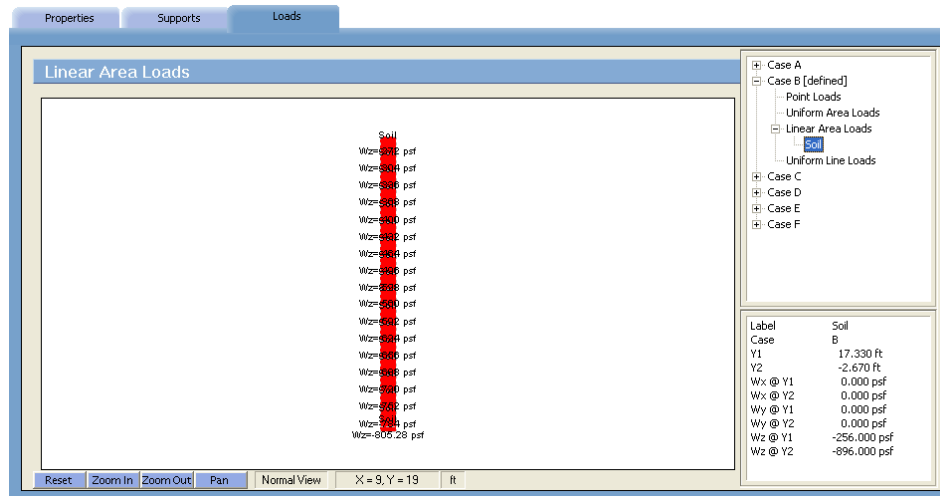

Solving

- From the **Solve** menu, click **Execute** to surface the ANALYSIS dialog box...

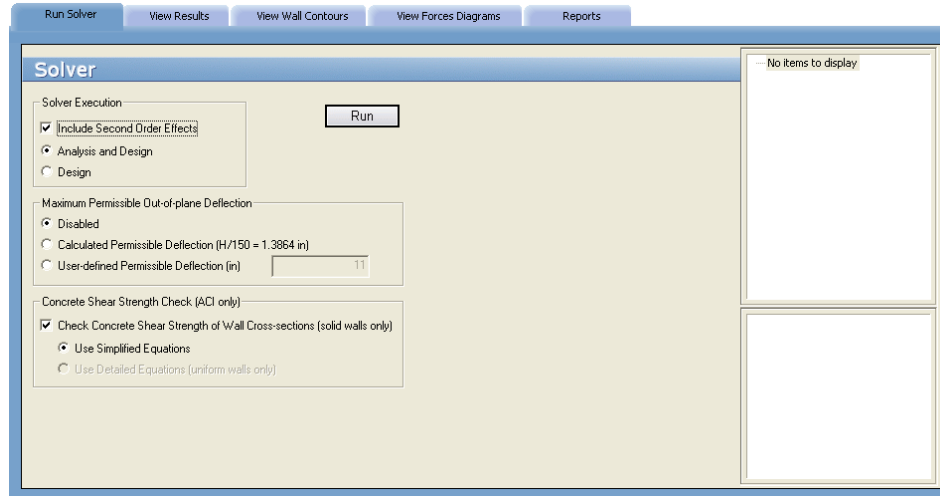

- Keep INCLUDE SECOND ORDER EFFECTS checked.
- Disable: MAXIMUM PERMISSIBLE OUT-OF-PLANE DEFLECTION
- Check: CHECK CONCRETE SHEAR STRENGTH OF WALL CROSS-SECTIONS (SOLID WALLS ONLY). Only the USE SIMPLIFIED EQUATIONS option will be available because the wall is not uniform due to thickness change along length.
- Click on the RUN button and then click on the SOLVE button.
- The spWall SOLVER window is displayed and the solver messages are listed. After the solution is done, the design will be performed and then the focus will immediately be passed to the VIEW RESULTS folder.

Viewing and Printing Results

17. After a successful run, view results in text format or forces diagrams by selecting an item from the ITEM LISTING AREA.

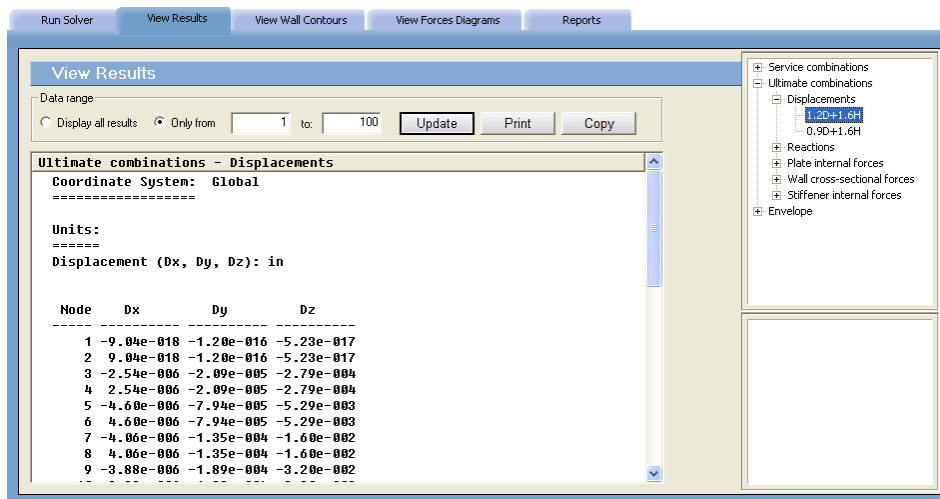

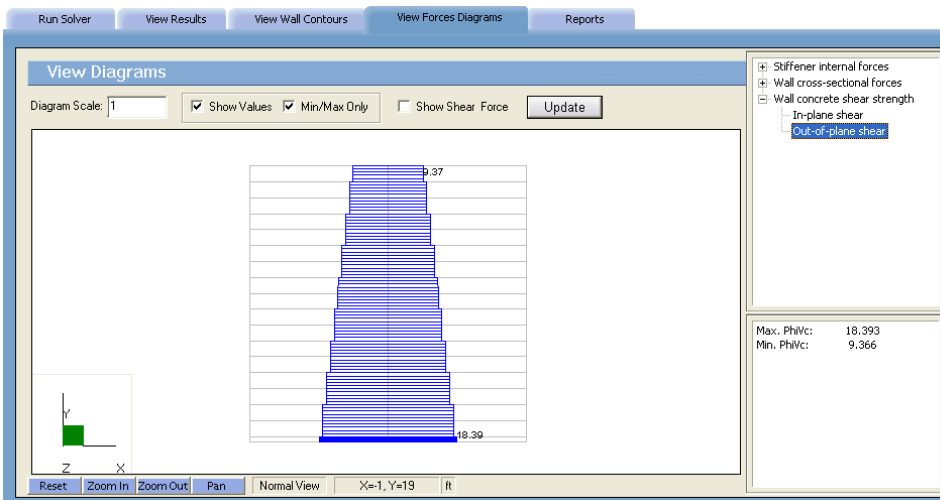
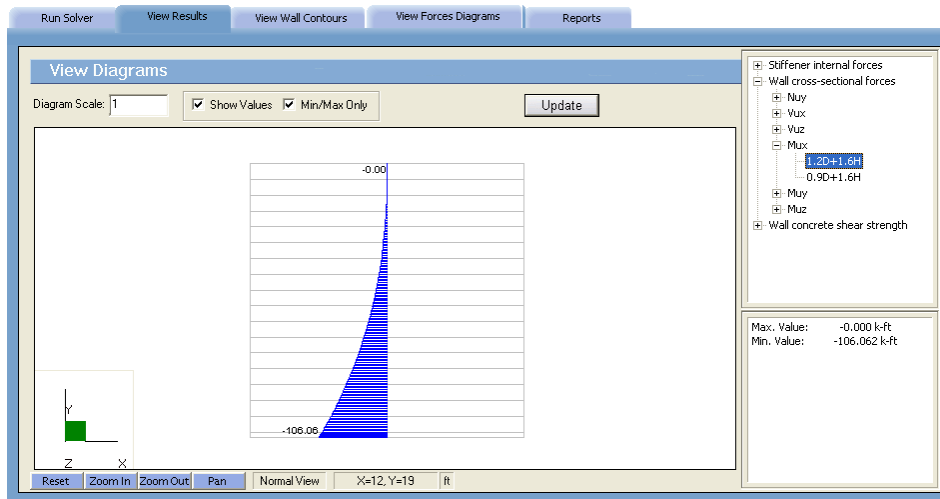
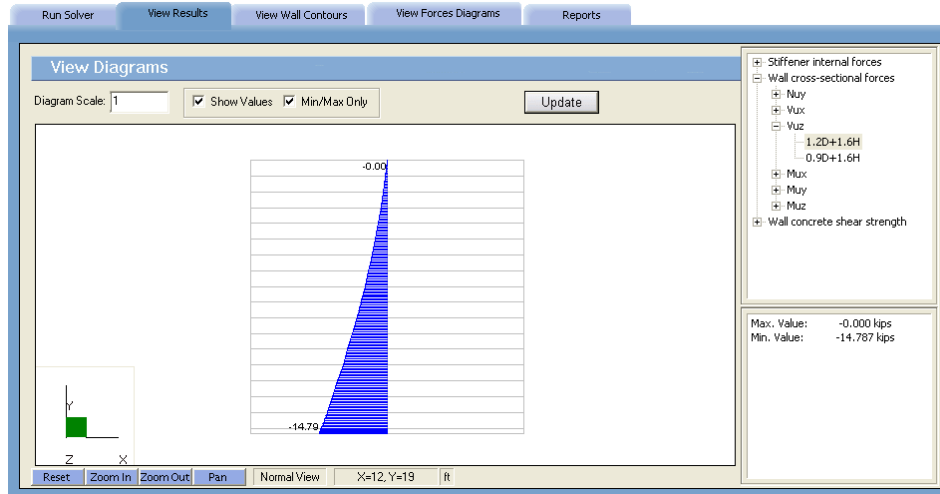

18. Results can be viewed in a contour form by selecting the VIEW CONTOUR folder

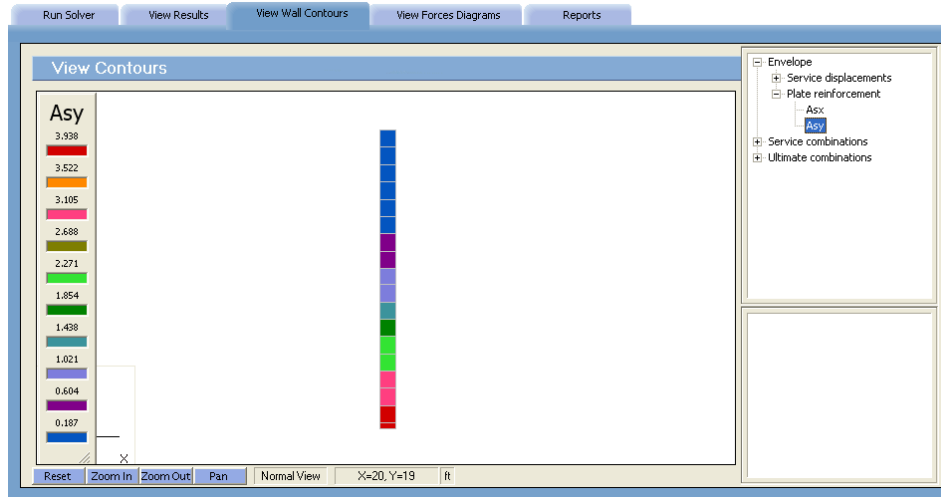

- Please be advised that spWall displays the total flexure reinforcement, for each element, for two curtains of reinforcement.

References

1. *Notes on ACI 318-08 Building Code Requirements for Structural Concrete*, Portland Cement Association, 2008.
2. W.K. Wang, C.G. Salmon, and J. A. Pincheira, *Reinforced Concrete Design*, John Wiley & Sons, Seventh Edition, 2007.

Appendix

Code Provisions

Flexure Design

A. ACI 318-11

$$\bullet \quad \phi = \begin{cases} 0.9 & \text{if } \varepsilon_t \geq 0.005 \\ 0.65 + \frac{0.25(\varepsilon_t - f_y/E_s)}{0.005 - f_y/E_s} & \text{if } f_y/E_y < \varepsilon_t < 0.005 \\ 0.65 & \text{if } \varepsilon_t \leq f_y/E_y \end{cases} \quad (9.3.2)$$

- Maximum usable $f_y = 80.0$ ksi (9.4)

- An elastic perfectly plastic stress-strain distribution is assumed for the reinforcing steel (10.2.4)

- Strains in concrete and steel are assumed directly proportional to the distance from neutral axis (10.2.2)

- Maximum concrete strain = 0.003 (10.2.3)

- Tensile strength of concrete is neglected (10.2.5)

- Equivalent rectangular stress distribution is used to represent the relationship between concrete compression stress and concrete strain (10.2.7)

- $f_c = 0.85 f'_c$ (10.2.7.1)

- $\beta_1 = \begin{cases} 0.85 & \text{if } f'_c \leq 4 \text{ ksi} \\ 0.85 - 0.05(f'_c - 4 \text{ ksi}) & \text{if } 4 < f'_c < 8 \text{ ksi} \\ 0.65 & \text{if } f'_c \geq 8 \text{ ksi} \end{cases}$ (10.2.7.3)

- Tension control starts at $\varepsilon_t = 0.005$ (10.3.4)

Compression control starts at $\varepsilon_t = \varepsilon_y = f_y/E_s$ (10.3.3)

- Maximum axial strength $\phi P_{n,max} = 0.80\phi(0.85f'_c(A_g - A_{st}) + f_y A_{st})$ (10.3.6.2)

- Minimum ratio of vertical reinforcement $\rho = 0.0012$ (14.3.2)

- Minimum ratio of horizontal reinforcement $\rho = 0.0020$ (14.3.3)

- Minimum ratio of reinforcement (both directions) in precast walls $\rho = 0.001$ (16.4.2)

- Ties are required for vertical reinforcement in compression if $\rho > 0.01$ (14.3.6)

- Maximum wall thickness with one curtain of reinforcement = 10 in (except basement walls) (14.3.4)

- $\Delta s \leq l_c/150$ (14.8.4)

B. ACI 318-08

$$\bullet \quad \phi = \begin{cases} 0.9 & \text{if } \varepsilon_t \geq 0.005 \\ 0.65 + \frac{0.25(\varepsilon_t - f_y/E_s)}{0.005 - f_y/E_s} & \text{if } f_y/E_y < \varepsilon_t < 0.005 \\ 0.65 & \text{if } \varepsilon_t \leq f_y/E_y \end{cases} \quad (9.3.2)$$

• Maximum usable $f_y = 80.0$ ksi (9.4)

• An elastic perfectly plastic stress-strain distribution is assumed for the reinforcing steel (10.2.4)

• Strains in concrete and steel are assumed directly proportional to the distance from neutral axis (10.2.2)

• Maximum concrete strain = 0.003 (10.2.3)

• Tensile strength of concrete is neglected (10.2.5)

• Equivalent rectangular stress distribution is used to represent the relationship between concrete compression stress and concrete strain (10.2.7)

• $f_c = 0.85 f'_c$ (10.2.7.1)

• $\beta_1 = \begin{cases} 0.85 & \text{if } f'_c \leq 4 \text{ ksi} \\ 0.85 - 0.05(f'_c - 4 \text{ ksi}) & \text{if } 4 < f'_c < 8 \text{ ksi} \\ 0.65 & \text{if } f'_c \geq 8 \text{ ksi} \end{cases}$ (10.2.7.3)

• Tension control starts at $\varepsilon_t = 0.005$ (10.3.4)

Compression control starts at $\varepsilon_t = \varepsilon_y = f_y/E_s$ (10.3.3)

• Maximum axial strength $\phi P_{n,\max} = 0.80\phi(0.85f'_c(A_g - A_{st}) + f_y A_{st})$ (10.3.6.2)

• Minimum ratio of vertical reinforcement $\rho = 0.0012$ (14.3.2)

• Minimum ratio of horizontal reinforcement $\rho = 0.0020$ (14.3.3)

• Minimum ratio of reinforcement (both directions) in precast walls $\rho = 0.001$ (16.4.2)

• Maximum wall thickness with one curtain of reinforcement = 10 in (except basement walls) (14.3.4)

• Ties are required for vertical reinforcement in compression if $\rho > 0.01$ (14.3.6)

• $\Delta s \leq l_c/150$ (14.8.4)

C. ACI 318-05

$$\bullet \quad \phi = \begin{cases} 0.9 & \text{if } \varepsilon_t \geq 0.005 \\ 0.65 + \frac{0.25(\varepsilon_t - f_y/E_s)}{0.005 - f_y/E_s} & \text{if } f_y/E_s < \varepsilon_t < 0.005 \\ 0.65 & \text{if } \varepsilon_t \leq f_y/E_s \end{cases} \quad (9.3.2)$$

$$\bullet \quad \text{Maximum usable } f_y = 80.0 \text{ ksi} \quad (9.4)$$

$$\bullet \quad \text{An elastic perfectly plastic stress-strain distribution is assumed for the reinforcing steel} \quad (10.2.4)$$

$$\bullet \quad \text{Strains in concrete and steel are assumed directly proportional to the distance from neutral axis} \quad (10.2.2)$$

$$\bullet \quad \text{Maximum concrete strain} = 0.003 \quad (10.2.3)$$

$$\bullet \quad \text{Tensile strength of concrete is neglected} \quad (10.2.5)$$

$$\bullet \quad \text{Equivalent rectangular stress distribution is used to represent the relationship between concrete compression stress and concrete strain} \quad (10.2.7)$$

$$\bullet \quad f_c = 0.85 f'_c \quad (10.2.7.1)$$

$$\bullet \quad \beta_1 = \begin{cases} 0.85 & \text{if } f'_c \leq 4 \text{ ksi} \\ 0.85 - 0.05(f'_c - 4 \text{ ksi}) & \text{if } 4 < f'_c < 8 \text{ ksi} \\ 0.65 & \text{if } f'_c \geq 8 \text{ ksi} \end{cases} \quad (10.2.7.3)$$

$$\bullet \quad \text{Tension control starts at } \varepsilon_t = 0.005 \quad (10.3.4)$$

$$\text{Compression control starts at } \varepsilon_t = \varepsilon_y = f_y/E_s \quad (10.3.3)$$

$$\bullet \quad \text{Maximum axial strength } \phi P_{n,\max} = 0.80\phi(0.85f'_c(A_g - A_{st}) + f_y A_{st}) \quad (10.3.6.2)$$

$$\bullet \quad \text{Minimum ratio of vertical reinforcement } \rho = 0.0012 \quad (14.3.2)$$

$$\bullet \quad \text{Minimum ratio of horizontal reinforcement } \rho = 0.0020 \quad (14.3.3)$$

$$\bullet \quad \text{Minimum ratio of reinforcement (both directions) in precast walls } \rho = 0.001 \quad (16.4.2)$$

$$\bullet \quad \text{Ties are required for vertical reinforcement in compression if } \rho > 0.01 \quad (14.3.6)$$

$$\bullet \quad \text{Maximum wall thickness with one curtain of reinforcement} = 10 \text{ in (except basement walls)} \quad (14.3.4)$$

$$\bullet \quad \Delta s \leq l_c/150 \quad (14.8.4)$$

D. ACI 318-02

$$\phi = \begin{cases} 0.9 & \text{if } \varepsilon_t \geq 0.005 \\ 0.65 + \frac{0.25(\varepsilon_t - f_y/E_s)}{0.005 - f_y/E_s} & \text{if } f_y/E_y < \varepsilon_t < 0.005 \\ 0.65 & \text{if } \varepsilon_t \leq f_y/E_y \end{cases} \quad (9.3.2)$$

- Maximum usable $f_y = 80.0$ ksi (9.4)

- An elastic perfectly plastic stress-strain distribution is assumed for the reinforcing steel (10.2.4)

- Strains in concrete and steel are assumed directly proportional to the distance from neutral axis (10.2.2)

- Maximum concrete strain = 0.003 (10.2.3)

- Tensile strength of concrete is neglected (10.2.5)

- Equivalent rectangular stress distribution is used to represent the relationship between concrete compression stress and concrete strain (10.2.7)

- $f_c = 0.85 f'_c$ (10.2.7.1)

- $\beta_1 = \begin{cases} 0.85 & \text{if } f'_c \leq 4 \text{ ksi} \\ 0.85 - 0.05(f'_c - 4 \text{ ksi}) & \text{if } 4 < f'_c < 8 \text{ ksi} \\ 0.65 & \text{if } f'_c \geq 8 \text{ ksi} \end{cases}$ (10.2.7.3)

- Tension control starts at $\varepsilon_t = 0.005$ (10.3.4)

Compression control starts at $\varepsilon_t = \varepsilon_y = f_y/E_s$ (10.3.3)

- Maximum axial strength $\phi P_{n,max} = 0.80\phi(0.85f'_c(A_g - A_{st}) + f_y A_{st})$ (10.3.6.2)

- Minimum ratio of vertical reinforcement $\rho = 0.0012$ (14.3.2)

- Minimum ratio of horizontal reinforcement $\rho = 0.0020$ (14.3.3)

- Minimum ratio of reinforcement (both directions) in precast walls $\rho = 0.001$ (16.4.2)

- Ties are required for vertical reinforcement in compression if $\rho > 0.01$ (14.3.6)

- Maximum wall thickness with one curtain of reinforcement = 10 in (except basement walls) (14.3.4)

- $\Delta s \leq l_c/150$ (14.8.4)

E. CSA A23.3-04

- $\phi_c = 0.65$ (8.4.2)

$\phi_c = 0.70$ for precast concrete (16.1.3)

- $\phi_s = 0.85$ (8.4.3)

- Maximum usable steel f_y in tension = 500 MPa (8.5.1)

- Maximum usable steel f_y in compression = 400 MPa (8.5.2)
 - An elastic perfectly plastic stress-strain distribution is assumed for the reinforcing steel (8.5.3.2)
 - Maximum usable concrete $f'_c = 80$ MPa (8.6.1.1)
 - Strains in concrete and steel are assumed directly proportional to the distance from neural axis (10.1.2)
 - Maximum concrete strain = .0035 (10.1.3)
 - Tensile strength of concrete is neglected (10.1.5)
 - Equivalent rectangular stress distribution is used to represent the relationship between concrete compression stress and concrete strain (10.1.7)
 - $f_c = \alpha_1 \phi_c f'_c$
 - $\alpha_1 = 0.85 - 0.0015f'_c \geq 0.67$
 - $\beta_1 = 0.97 - 0.0025f'_c \geq 0.67$
 - Maximum factored axial load resistance (P_r) = 0.8 P_{ro} (10.10.4)
 - Minimum ratio of vertical reinforcement $\rho = 0.0015$ (14.1.8.5)
 - Minimum ratio of horizontal reinforcement $\rho = 0.0020$ (14.1.8.6)
 - Minimum ratio of reinforcement (both directions) in precast walls $\rho = 0.001$ (16.4.3.3)
 - Ties are required for vertical reinforcement in compression if $\rho > 0.005$ (14.1.8.7)
 - Maximum wall thickness with one curtain of reinforcement = 250 mm (except basement and retaining walls) (14.1.8.3)
 - $\Delta s \leq l/100$ (23.3.2)
- F. CSA A23.3-94
- $\phi_c = 0.6$ (8.4.2)
 - $\phi_s = 0.85$ (8.4.3)
 - Maximum usable steel f_y in tension = 500 MPa (8.5.1)
 - Maximum usable steel f_y in compression = 400 MPa (8.5.2)
 - An elastic perfectly plastic stress-strain distribution is assumed for the reinforcing steel (8.5.3.2)
 - Maximum usable concrete $f'_c = 80$ MPa (8.6.1.1)
 - Strains in concrete and steel are assumed directly proportional to the distance from neural axis (10.1.2)
 - Maximum concrete strain = .0035 (10.1.3)
 - Tensile strength of concrete is neglected (10.1.5)
 - Equivalent rectangular stress distribution is used to represent the relationship between concrete compression stress and concrete strain (10.1.7)

- $f_c = \alpha_1 \phi_c f'_c$
- $\alpha_1 = 0.85 - 0.0015f'_c \geq 0.67$
- $\beta_1 = 0.97 - 0.0025f'_c \geq 0.67$
- Maximum factored axial load resistance $(P_r) = 0.8 P_{r0}$ (10.10.4)
- Minimum ratio of vertical reinforcement $\rho = 0.0015$ (14.3.2)
- Minimum ratio of horizontal reinforcement $\rho = 0.0020$ (14.3.3)
- Minimum ratio of reinforcement (both directions) in precast walls $\rho = 0.001$ (16.4.3.4)
- Ties are required for vertical reinforcement in compression if $\rho > 0.01$ (14.3.6)
- Maximum wall thickness with one curtain of reinforcement = 250 mm (14.3.4)
- $\Delta s \leq 1/100$ (23.4.2)

Wall Shear Strength Provided by Concrete

Refer to section Wall Shear on Page 2-14

Shear and Torsion Design of Stiffener Elements

A. ACI 318-11

- Definitions:

d = Distance from extreme compression fiber to centroid of longitudinal tension reinforcement. For a circular section $d \geq 0.8$ diameter

b_w = Web width or diameter of circular section.

$$V_s = \frac{V_u}{\phi} - V_c \geq 0$$

$$T_n = \frac{T_u}{\phi}$$

- $\phi = 0.75$ (9.3.2.3)
- Maximum usable $f_{yt} = 60.0$ ksi (11.5.2)
- Lightweight concrete (8.6.1)

$$\lambda = 1.0, \text{ if } w_c \geq 135 \text{ pcf } (2155 \text{ kg/m}^3)$$

$$\lambda = 0.85, \text{ if } 115 \text{ pcf } (1840 \text{ kg/m}^3) < w_c < 135 \text{ pcf } (2155 \text{ kg/m}^3)$$

$$\lambda = 0.75, \text{ if } w_c \leq 115 \text{ pcf } (1840 \text{ kg/m}^3) \quad (2.2)$$

- Shear strength provided by concrete:

$$V_c = 2 \left(1 + \frac{N_u}{2000A_g} \right) \lambda \sqrt{f'_c} b_w d \quad N_u \geq 0 \text{ (compression)} \quad (11.2.1.2)$$

$$V_c = 2 \left(1 + \frac{N_u}{500A_g} \right) \lambda \sqrt{f'_c} b_w d \geq 0 \quad N_u \leq 0 \text{ (tension)} \quad (11.2.2.3)$$

- Shear reinforcement

- Shear reinforcement should be provided if $v_u > 0.5 v_c$ (11.4.6.1)

- $\frac{A_v}{s} = \frac{V_s}{f_{yt} d}$ (11.4.6.2)

- Maximum spacing of stirrups

- $0.5 d \leq 24 \text{ inches}$ for $V_s \leq 4 \sqrt{f'_c} b_w d_v$ (11.4.5.1)

- $0.25 d \leq 12 \text{ inches}$ for $V_s > 4 \sqrt{f'_c} b_w d_v$ (11.4.5.3)

- Torsion reinforcement

- Torsion reinforcement should be provided if

- $T_u > \phi \lambda \left(\frac{A_{cp}^2}{P_{cp}} \right) \sqrt{f'_c} \sqrt{1 + \frac{N_u}{4A_g \sqrt{f'_c}}}$ (11.5.1(c))

- $\frac{A_t}{s} = \frac{T_n}{2A_o f_{yt}}$ (11.5.3.6)

- $A_l = \frac{A_t}{s} P_h \left(\frac{f_{yv}}{f_{yl}} \right)$ (11.5.3.7)

- Minimum $A_l = \frac{5\lambda \sqrt{f'_c} A_{cp}}{f_y} - \frac{A_t}{s} P_h \frac{f_{yt}}{f_y}$ for $\frac{A_t}{s} \geq \frac{25b_w}{f_{yt}}$ (11.5.5.3)

- Maximum spacing of stirrups

- $\frac{P_h}{8} \leq 12.0 \text{ inches}$ (11.5.6.1)

- Minimum shear reinforcement

- Minimum $\left(\frac{A_v}{s} + 2 \frac{A_t}{s} \right) = 0.75 \lambda \sqrt{f'_c} \frac{b_w}{f_{yt}} \geq 50 \frac{b_w}{f_{yt}}$ (11.5.5.2)

Total shear stress

- Maximum shear stress

- $\sqrt{\left(\frac{V_u}{b_w d} \right)^2 + \left(\frac{T_u P_h}{1.7 A_{oh}^2} \right)} < \phi \left(\frac{V_c}{b_w d} + 8 \lambda \sqrt{f'_c} \right)$ (11.5.3.1)

B. ACI 318-08

- Definitions:

- $d =$ Distance from extreme compression fiber to centroid of longitudinal tension reinforcement. For a circular section $d \geq 0.8$ diameter

b_w = Web width or diameter of circular section.

$$V_s = \frac{V_u}{\phi} - V_c \geq 0$$

$$T_n = \frac{T_u}{\phi}$$

- $\phi = 0.75$ (9.3.2.3)
- Maximum usable $f_{yt} = 60.0$ ksi (11.5.2)
- Lightweight concrete (8.6.1)

$$\lambda = 1.0, \text{ if } w_c \geq 135 \text{pcf } (2155 \text{kg/m}^3)$$

$$\lambda = 0.85, \text{ if } 115 \text{pcf } (1840 \text{kg/m}^3) < w_c < 135 \text{pcf } (2155 \text{kg/m}^3)$$

$$\lambda = 0.75, \text{ if } w_c \leq 115 \text{pcf } (1840 \text{kg/m}^3)$$

- Shear strength provided by concrete:

$$V_c = 2 \left(1 + \frac{N_u}{2000A_g} \right) \lambda \sqrt{f'_c} b_w d \quad N_u \geq 0 \text{ (compression)} \quad (11.2.1.2)$$

$$V_c = 2 \left(1 + \frac{N_u}{500A_g} \right) \lambda \sqrt{f'_c} b_w d \geq 0 \quad N_u \leq 0 \text{ (tension)} \quad (11.2.2.3)$$

- Shear reinforcement

- Shear reinforcement should be provided if $v_u > 0.5 v_c$ (11.4.6.1)

$$\frac{A_v}{s} = \frac{V_s}{f_{yt} d} \quad (11.4.6.2)$$

- Maximum spacing of stirrups

$$0.5 d \leq 24 \text{ inches} \quad \text{for } V_s \leq 4 \sqrt{f'_c} b_w d_v \quad (11.4.5.1)$$

$$0.25 d \leq 12 \text{ inches} \quad \text{for } V_s > 4 \sqrt{f'_c} b_w d_v \quad (11.4.5.3)$$

- Torsion reinforcement

- Torsion reinforcement should be provided if

$$T_u > \phi \lambda \left(\frac{A_{cp}^2}{P_{cp}} \right) \sqrt{f'_c} \sqrt{1 + \frac{N_u}{4A_g \sqrt{f'_c}}} \quad (11.5.1(c))$$

$$\frac{A_t}{s} = \frac{T_n}{2A_o f_{yt}} \quad (11.5.3.6)$$

$$A_l = \frac{A_t}{s} P_h \left(\frac{f_{yv}}{f_{yl}} \right) \quad (11.5.3.7)$$

- Minimum $A_l = \frac{5\lambda\sqrt{f'_c}A_{cp}}{f_y} - \frac{A_t}{s}p_h \frac{f_{yt}}{f_y}$ for $\frac{A_t}{s} \geq \frac{25b_w}{f_{yt}}$ (11.5.5.3)

- Maximum spacing of stirrups

$$\frac{p_h}{8} \leq 12.0 \text{ inches} \quad (11.5.6.1)$$

- Minimum shear reinforcement

$$\text{Minimum } \left(\frac{A_v}{s} + 2 \frac{A_t}{s} \right) = 0.75\lambda\sqrt{f'_c} \frac{b_w}{f_{yt}} \geq 50 \frac{b_w}{f_{yt}} \quad (11.5.5.2)$$

Total shear stress

- Maximum shear stress

$$\sqrt{\left(\frac{V_u}{b_w d} \right)^2 + \left(\frac{T_u p_h}{1.7 A_{oh}^2} \right)} < \phi \left(\frac{V_c}{b_w d} + 8\lambda\sqrt{f'_c} \right) \quad (11.5.3.1)$$

C. ACI 318-05

- Definitions:

d = Distance from extreme compression fiber to centroid of longitudinal tension reinforcement. For a circular section $d \geq 0.8$ diameter

b_w = Web width or diameter of circular section.

$$V_s = \frac{V_u}{\phi} - V_c \geq 0$$

$$T_n = \frac{T_u}{\phi}$$

- $\phi = 0.75$ (9.3.2.3)

- Maximum usable $f_{yt} = 60.0$ ksi (11.5.2)

- Lightweight concrete (11.2.1.2)

$$\lambda = 1.0, \text{ if } w_c \geq 135 \text{ pcf } (2155 \text{ kg/m}^3)$$

$$\lambda = 0.85, \text{ if } 115 \text{ pcf } (1840 \text{ kg/m}^3) < w_c < 135 \text{ pcf } (2155 \text{ kg/m}^3)$$

$$\lambda = 0.75, \text{ if } w_c \leq 115 \text{ pcf } (1840 \text{ kg/m}^3)$$

- Shear strength provided by concrete:

$$V_c = 2 \left(1 + \frac{N_u}{2000A_g} \right) \lambda \sqrt{f'_c} b_w d \quad N_u \geq 0 \text{ (compression)} \quad (11.3.1.2)$$

$$V_c = 2 \left(1 + \frac{N_u}{500A_g} \right) \lambda \sqrt{f'_c} b_w d \geq 0 \quad N_u \leq 0 \text{ (tension)} \quad (11.3.2.3)$$

- Shear reinforcement

- Shear reinforcement should be provided if $v_u > 0.5 v_c$ (11.5.5.1)

- $$\frac{A_v}{s} = \frac{V_s}{f_{yt} d}$$
 (11.5.6.2)

- Maximum spacing of stirrups

$$0.5 d \leq 24 \text{ inches} \quad \text{for } V_s \leq 4 \sqrt{f'_c} b_w d_v \quad (11.5.4.1)$$

$$0.25 d \leq 12 \text{ inches} \quad \text{for } V_s > 4 \sqrt{f'_c} b_w d_v \quad (11.5.4.3)$$

- Torsion reinforcement

- Torsion reinforcement should be provided if

$$T_u > \phi \lambda \left(\frac{A_{cp}^2}{P_{cp}} \right) \sqrt{f'_c} \sqrt{1 + \frac{N_u}{4A_g \sqrt{f'_c}}} \quad (11.6.1(c))$$

- $$\frac{A_t}{s} = \frac{T_n}{2A_o f_{yt}} \quad (11.6.3.6)$$

- $$A_1 = \frac{A_t}{s} P_h \left(\frac{f_{yv}}{f_{yl}} \right) \quad (11.6.3.7)$$

- Minimum $A_1 = \frac{5\lambda \sqrt{f'_c} A_{cp}}{f_y} - \frac{A_t}{s} P_h \frac{f_{yt}}{f_y}$ for $\frac{A_t}{s} \geq \frac{25b_w}{f_{yt}}$ (11.6.5.3)

- Maximum spacing of stirrups

$$\frac{P_h}{8} \leq 12.0 \text{ inches} \quad (11.6.6.1)$$

- Minimum shear reinforcement

$$\text{Minimum } \left(\frac{A_v}{s} + 2 \frac{A_t}{s} \right) = 0.75 \lambda \sqrt{f'_c} \frac{b_w}{f_{yt}} \geq 50 \frac{b_w}{f_{yt}} \quad (11.6.5.2)$$

Total shear stress

- Maximum shear stress

$$\sqrt{\left(\frac{V_u}{b_w d} \right)^2 + \left(\frac{T_u P_h}{1.7 A_{oh}^2} \right)} < \phi \left(\frac{V_c}{b_w d} + 8 \lambda \sqrt{f'_c} \right) \quad (11.6.3.1)$$

D. ACI 318-02

- Definitions:

d = Distance from extreme compression fiber to centroid of longitudinal tension reinforcement. For a circular section $d \geq 0.8$ diameter

b_w = Web width or diameter of circular section.

$$V_s = \frac{V_u}{\phi} - V_c \geq 0$$

$$T_n = \frac{T_u}{\phi}$$

- $\phi = 0.75$ (9.3.2.3)

- Maximum usable $f_{yv} = 60.0$ ksi (11.5.2)

- Lightweight concrete (11.2.1.2)

$$\lambda = 1.0, \text{ if } w_c \geq 135 \text{pcf } (2155 \text{kg/m}^3)$$

$$\lambda = 0.85, \text{ if } 115 \text{pcf } (1840 \text{kg/m}^3) < w_c < 135 \text{pcf } (2155 \text{kg/m}^3)$$

$$\lambda = 0.75, \text{ if } w_c \leq 115 \text{pcf } (1840 \text{kg/m}^3)$$

Linear relationship between w_c and λ is assumed between the abovementioned values.

- Shear strength provided by concrete:

$$V_c = 2 \left(1 + \frac{N_u}{2000A_g} \right) \lambda \sqrt{f'_c} b_w d \quad N_u \geq 0 \text{ (compression)} \quad (11.3.1.2)$$

$$V_c = 2 \left(1 + \frac{N_u}{500A_g} \right) \lambda \sqrt{f'_c} b_w d \geq 0 \quad N_u \leq 0 \text{ (tension)} \quad (11.3.2.3)$$

- Shear reinforcement

- Shear reinforcement should be provided if $v_u > 0.5 v_c$ (11.5.5.1)

- $\frac{A_v}{s} = \frac{V_s}{f_{yv} d}$ (11.5.6.2)

- Maximum spacing of stirrups

$$0.5 d \leq 24 \text{ inches} \quad \text{for } V_s \leq 4 \sqrt{f'_c} b_w d_v \quad (11.5.4.1)$$

$$0.25 d \leq 12 \text{ inches} \quad \text{for } V_s > 4 \sqrt{f'_c} b_w d_v \quad (11.5.4.3)$$

- Torsion reinforcement

- Torsion reinforcement should be provided if

$$T_u > \phi \lambda \left(\frac{A_{cp}^2}{P_{cp}} \right) \sqrt{f'_c} \sqrt{1 + \frac{N_u}{4A_g \sqrt{f'_c}}} \quad (11.6.1(c))$$

- $\frac{A_t}{s} = \frac{T_n}{2A_o f_{yv}}$ (11.6.3.6)

- $A_l = \frac{A_t}{s} P_h \left(\frac{f_{yv}}{f_{yl}} \right)$ (11.6.3.7)

- Minimum $A_l = \frac{5\lambda \sqrt{f'_c} A_{cp}}{f_{yl}} - \frac{A_t}{s} p_h \frac{f_{yv}}{f_{yl}}$ for $\frac{A_t}{s} \geq \frac{25b_w}{f_{yv}}$ (11.6.5.3)

- Maximum spacing of stirrups

$$\frac{p_h}{8} \leq 12.0 \text{ inches} \quad (11.6.6.1)$$

- Minimum shear reinforcement

$$\text{Minimum } \left(\frac{A_v}{s} + 2 \frac{A_t}{s} \right) = 0.75 \lambda \sqrt{f'_c} \frac{b_w}{f_{yv}} \geq 50 \frac{b_w}{f_{yv}} \quad (11.6.5.2)$$

Total shear stress

- Maximum shear stress

$$\sqrt{\left(\frac{V_u}{b_w d} \right)^2 + \left(\frac{T_u p_h}{1.7 A_{oh}^2} \right)} < \phi \left(\frac{V_c}{b_w d} + 8 \lambda \sqrt{f'_c} \right) \quad (11.6.3.1)$$

E. CSA A23.3-04 (simplified method)

- Definitions:

d = Distance from extreme compression fiber to centroid of longitudinal tension reinforcement. For circular section, distance from extreme compression fiber to centroid of longitudinal reinforcement in the opposite half

h = Overall height of member

d_v = Greater of $0.9d$ and $0.72h$

b_w = Web width or diameter of circular section. (11.2.10.3)

$$V_s = V_f - V_c \geq 0 \quad v_c = \frac{V_c}{b_w d_v} \quad v_f = \frac{V_f}{b_w d_v}$$

$$\tau_c = \left(\frac{T_f p_{cp}}{A_{cp}^2} \right) \quad \tau_f = \left(\frac{T_f p_h}{A_{oh}^2} \right)$$

- $\phi_c = 0.65$ (8.4.2)

$\phi_c = 0.70$ for precast concrete (16.1.3)

$\phi_s = 0.85$ (8.4.3)

- Maximum usable $f'_c = 60$ MPa (11.3.6.3)

- Maximum usable $f_y = 400$ MPa (11.3.6.3)

- Lightweight concrete (2.1, 8.6.5)

$\lambda = 1.0$, if $w_c \geq 2150 \text{ kg/m}^3$ (134.2pcf)

$\lambda = 0.85$, if 1850 kg/m^3 (115.5pcf) $< w_c < 2150 \text{ kg/m}^3$ (134.2pcf)

$\lambda = 0.75$, if $w_c \leq 1850 \text{ kg/m}^3$ (115.5pcf)

- Shear strength provided by concrete (assuming no significant tension):

$$V_c = \phi_c \lambda \beta \sqrt{f'_c} b_w d_v \quad (11.3.4)$$

where

$$\sqrt{f'_c} \leq 8 \text{ MPa}$$

$$\beta = 0.18 \text{ if at least minimum transverse reinforcement is provided} \quad (11.3.6(a))$$

$$\beta = \frac{230}{1000 + d_v} \text{ without transverse reinforcement} \quad (11.3.6(b))$$

- Shear reinforcement

- Shear reinforcement should be provided if $v_f > v_c$ (11.2.8.1)

- $\frac{A_v}{s} = \frac{V_s}{\phi_s f_y d_v}$ (11.3.5.1)

- Maximum spacing of stirrups

$$0.7 d_v \leq 600 \text{ mm} \quad \text{if } V_f \leq 0.125 \lambda \phi_c f'_c b_w d \text{ and } T_f \leq 0.25 T_{cr} \quad (11.3.8.1)$$

$$0.35 d_v \leq 300 \text{ mm} \quad \text{if } V_f > 0.125 \lambda \phi_c f'_c b_w d \text{ or } T_f > 0.25 T_{cr} \quad (11.3.8.3)$$

- Torsion reinforcement

- Torsion reinforcement should be provided if

$$T_f > 0.095 \phi_c \lambda \sqrt{f'_c} \frac{A_c^2}{p_c} \quad (11.2.9.1)$$

- $\frac{A_t}{s} = \frac{T_f}{2A_o \phi_s f_y \cot 35^\circ}$ (11.3.10.3)

- $A_{It} = \frac{M_f / d_v + 0.5N_f + \cot 35^\circ \sqrt{(V_f - V_p)^2 + \left(\frac{0.45p_h T_f}{2A_o}\right)}}{\phi_s f_y}$ (11.3.9.2)

- $A_{Ib} = \frac{-M_f / d_v + 0.5N_f + \cot 35^\circ \sqrt{(V_f - V_p)^2 + \left(\frac{0.45p_h T_f}{2A_o}\right)}}{\phi_s f_y}$ (11.3.9.3)

- Minimum shear reinforcement

$$\left(\frac{A_v}{s} + 2 \frac{A_t}{s}\right) \geq 0.06 \sqrt{f'_c} \frac{b_w}{f_y} \quad (11.2.8.2)$$

- Cross-sectional dimensions to avoid crushing

$$\sqrt{\left(\frac{V_f}{b_w d_v}\right)^2 + \left(\frac{T_f p_h}{1.7 A_{oh}^2}\right)^2} \leq 0.25 \phi_c f'_c \quad (11.3.10.4)$$

- Maximum factored shear resistance M

$$V_r \leq 0.25 \phi_c f'_c b_w d \quad (11.3.3)$$

F. CSA A23.3-94 (simplified method)

- Definitions:

d = Distance from extreme compression fiber to centroid of longitudinal tension reinforcement. For circular section, distance from extreme compression fiber to centroid of longitudinal reinforcement in the opposite half.

b_w = Web width or (0.8 diameter) of circular section. (11.2.10)

$$V_s = V_f - V_c \geq 0 \quad v_c = \frac{V_c}{b_w d} \quad v_f = \frac{V_f}{b_w d}$$

$$\tau_c = \left(\frac{T_f P_{cp}}{A_{cp}^2} \right) \quad \tau_f = \left(\frac{T_f P_h}{A_{oh}^2} \right)$$

- $\phi_c = 0.6$ (8.4.2)

- $\phi_s = 0.85$ (8.4.3)

- Maximum usable $f_y = 500$ MPa (8.5.1)

- Lightweight concrete (2.1, 8.6.5)

$\lambda = 1.0$, if $w_c \geq 2150 \text{ kg/m}^3$ (134.2 pcf)

$\lambda = 0.85$, if 1850 kg/m^3 (115.5 pcf) $< w_c < 2150 \text{ kg/m}^3$ (134.2 pcf)

$\lambda = 0.75$, if $w_c \leq 1850 \text{ kg/m}^3$ (115.5 pcf)

Linear relationship between w_c and λ is assumed between the abovementioned values.

- Shear strength provided by concrete:

$$V_c = 0.2 \lambda \phi_c \sqrt{f'_c} b_w d \quad N_f \geq 0 \text{ (compression)} \quad (11.3.5.1)$$

$$V_c = 0.2 \left(1 + \frac{N_f}{0.6 \lambda \phi_c \sqrt{f'_c} A_g} \right) \lambda \phi_c \sqrt{f'_c} b_w d \quad N_f < 0 \text{ (tension)}$$

(CSA A23.3-84/11.3.4.2)

- Shear reinforcement

- Shear reinforcement should be provided if $v_f > 0.5 v_c$ (11.2.8.1)

- $\frac{A_v}{s} = \frac{V_s}{\phi_s f_y d}$ (11.3.7)

- Maximum spacing of stirrups (11.2.11)

$$0.7 d \leq 600 \text{ mm} \quad \text{for } V_f < 0.1 \lambda \phi_c f'_c b_w d$$

$$0.35 d \leq 300 \text{ mm} \quad \text{for } V_f \geq 0.1 \lambda \phi_c f'_c b_w d$$

- Torsion reinforcement

- Torsion reinforcement should be provided if

$$T_f > 0.1\phi_c\lambda\sqrt{f'_c}\frac{A_c^2}{p_c} \quad (11.2.9.1)$$

- $$\frac{A_t}{s} = \frac{T_f}{2A_o\phi_s f_y} \quad (11.3.9.4)$$

- $$A_l = \frac{A_t}{s} p_h \quad (11.3.9.5)$$

- Maximum spacing of stirrups

$$\frac{p_h}{8} \leq 300 \text{ mm} \quad (\text{CSA A23.3-84/11.3.8.4})$$

- Minimum shear reinforcement

$$\left(\frac{A_v}{s} + 2\frac{A_t}{s}\right) \geq 0.06\sqrt{f'_c}\frac{b_w}{f_y} \quad (11.2.8.4)$$

- Cross-sectional dimensions to avoid crushing

$$\frac{V_f}{b_w d} + \frac{T_f p_h}{A_{oh}^2} \leq 0.25\phi_c f'_c \quad (11.3.9.8)$$

- Maximum shear resistance

$$V_r \leq V_c + 0.8\lambda\phi_c\sqrt{f'_c}b_w d \quad (11.3.4)$$

Default Load Cases and Combination Factors

The following load cases are predefined in the input file templates (activated in OPTIONS / STARTUP DEFAULTS window): A – Dead (D), B – Live (L), C – Snow (S), D – Wind (W), E – Earthquake (E), F – Soil (H). The template input files also include default load combination factors for service and ultimate load combinations as shown below.

For ACI 318-11

- Service load combinations^{26,27}

$$S1 = 1.0D + 1.0L$$

$$S2 = 1.0D + 0.5S$$

$$S3 = 1.0D + 0.5L$$

$$S4 = 1.0D + 0.5L + 0.7W$$

$$S5 = 1.0D + 0.5L - 0.7W$$

- Ultimate load combinations²⁸

$$U1 = 1.4D$$

$$U2 = 1.2D + 1.6L + 0.5S$$

$$U3 = 1.2D + 1.0L + 1.6S$$

²⁶ ASCE 7-10, Commentary, Appendix C, Serviceability Considerations.

²⁷ For consistency with the previous ASCE 7 code, it is assumed for wind load that $W_a \approx 0.7W$ with W_a based on 10-year MRI wind and W based on service level wind loads corresponding to 50-year MRI. Based on engineering judgment and in consultation with the client, ASCE 7-10 allows the engineer to select different MRI for W_a which will lead to different service load level combination factor.

²⁸ ACI 318-11, 9.2 (assuming W based on service-level wind load as in Footnote 26 and E based on ultimate-level forces)

$$\begin{aligned}
 U4 &= 1.2D + 1.6S + 0.5W \\
 U5 &= 1.2D + 1.6S - 0.5W \\
 U6 &= 1.2D + 1.0L + 0.5S + 1.6W \\
 U7 &= 1.2D + 1.0L + 0.5S - 1.6W \\
 U8 &= 0.9D + 1.6W \\
 U9 &= 0.9D - 1.6W \\
 U10 &= 1.2D + 1.0L + 0.2S + 1.0E \\
 U11 &= 1.2D + 1.0L + 0.2S - 1.0E \\
 U12 &= 0.9D + 1.0E \\
 U13 &= 0.9D - 1.0E \\
 U14 &= 1.4D + 1.6H \\
 U15 &= 1.4D + 0.9H \\
 U16 &= 1.2D + 1.6L + 0.5S + 1.6H \\
 U17 &= 1.2D + 1.6L + 0.5S + 0.9H \\
 U18 &= 1.2D + 1.0L + 1.6S + 1.6H \\
 U19 &= 1.2D + 1.0L + 1.6S + 0.9H \\
 U20 &= 1.2D + 1.6S + 0.5W + 1.6H \\
 U21 &= 1.2D + 1.6S + 0.5W + 0.9H \\
 U22 &= 1.2D + 1.6S - 0.5W + 1.6H \\
 U23 &= 1.2D + 1.6S - 0.5W + 0.9H \\
 U24 &= 1.2D + 1.0L + 0.5S + 1.6W + 1.6H \\
 U25 &= 1.2D + 1.0L + 0.5S + 1.6W + 0.9H \\
 U26 &= 1.2D + 1.0L + 0.5S - 1.6W + 1.6H \\
 U27 &= 1.2D + 1.0L + 0.5S - 1.6W + 0.9H \\
 U28 &= 0.9D + 1.6W + 1.6H \\
 U29 &= 0.9D + 1.6W + 0.9H \\
 U30 &= 0.9D - 1.6W + 1.6H \\
 U31 &= 0.9D - 1.6W + 0.9H \\
 U32 &= 1.2D + 1.0L + 0.2S + 1.0E + 1.6H \\
 U33 &= 1.2D + 1.0L + 0.2S + 1.0E + 0.9H \\
 U34 &= 1.2D + 1.0L + 0.2S - 1.0E + 1.6H \\
 U35 &= 1.2D + 1.0L + 0.2S - 1.0E + 0.9H \\
 U36 &= 0.9D + 1.0E + 1.6H \\
 U37 &= 0.9D + 1.0E + 0.9H \\
 U38 &= 0.9D - 1.0E + 1.6H \\
 U39 &= 0.9D - 1.0E + 0.9H
 \end{aligned}$$

For ACI 318-08/05/02

- Service load combinations²⁹

$$\begin{aligned}
 S1 &= 1.0D + 1.0L \\
 S2 &= 1.0D + 0.5S \\
 S3 &= 1.0D + 0.5L
 \end{aligned}$$

²⁹ ASCE 7-05, Errata, Chapter C Appendix C (Commentary on Appendix C)

$$S4 = 1.0D + 0.5L + 0.7W$$

$$S5 = 1.0D + 0.5L - 0.7W$$

- Ultimate load combinations³⁰

$$U1 = 1.4D$$

$$U2 = 1.2D + 1.6L + 0.5S + 1.6H$$

$$U3 = 1.2D + 1.0L + 1.6S$$

$$U4 = 1.2D + 1.6S + 0.8W$$

$$U5 = 1.2D + 1.6S - 0.8W$$

$$U6 = 1.2D + 1.0L + 0.5S + 1.6W$$

$$U7 = 1.2D + 1.0L + 0.5S - 1.6W$$

$$U8 = 0.9D + 1.6W$$

$$U9 = 0.9D - 1.6W$$

$$U10 = 0.9D + 1.6W + 1.6H$$

$$U11 = 0.9D - 1.6W + 1.6H$$

$$U12 = 1.2D + 1.0L + 0.2S + 1.0E$$

$$U13 = 1.2D + 1.0L + 0.2S - 1.0E$$

$$U14 = 0.9D + 1.0E$$

$$U15 = 0.9D - 1.0E$$

$$U16 = 0.9D + 1.0E + 1.6H$$

$$U17 = 0.9D - 1.0E + 1.6H$$

For CSA A23.3-04

- Service load combinations³¹

$$S1 = 1.0D$$

$$S2 = 1.0D + 1.0L$$

$$S3 = 1.0D + 1.0S$$

$$S4 = 1.0D + 1.0H$$

$$S5 = 1.0D + 1.0W$$

$$S6 = 1.0D - 1.0W$$

- Ultimate load combinations³²

$$U1 = 1.4D$$

$$U2 = 1.25D + 1.5L$$

$$U3 = 1.25D + 1.5L + 1.5H$$

$$U4 = 1.25D + 1.5L + 0.5S$$

$$U5 = 1.25D + 1.5L + 0.5S + 1.5H$$

$$U6 = 1.25D + 1.5L + 0.4W$$

$$U7 = 1.25D + 1.5L + 0.4W + 1.5H$$

$$U8 = 1.25D + 1.5L - 0.4W$$

$$U9 = 1.25D + 1.5L - 0.4W + 1.5H$$

$$U10 = 0.9D + 1.5L$$

³⁰ ACI 318-08, 9.2; ACI 318-05, 9.2; ACI 318-02, 9.2

³¹ CSA A23.3-04, 8.3.3

³² CSA A23.3-04, Annex C

$$\begin{aligned}
 U11 &= 0.9D + 1.5L + 1.5H \\
 U12 &= 0.9D + 1.5L + 0.5S \\
 U13 &= 0.9D + 1.5L + 0.5S + 1.5H \\
 U14 &= 0.9D + 1.5L + 0.4W \\
 U15 &= 0.9D + 1.5L + 0.4W + 1.5H \\
 U16 &= 0.9D + 1.5L - 0.4W \\
 U17 &= 0.9D + 1.5L - 0.4W + 1.5H \\
 U18 &= 1.25D + 1.5S \\
 U19 &= 1.25D + 1.5S + 1.5H \\
 U20 &= 1.25D + 0.5L + 1.5S \\
 U21 &= 1.25D + 0.5L + 1.5S + 1.5H \\
 U22 &= 1.25D + 1.5S + 0.4W \\
 U23 &= 1.25D + 1.5S + 0.4W + 1.5H \\
 U24 &= 1.25D + 1.5S - 0.4W \\
 U25 &= 1.25D + 1.5S - 0.4W + 1.5H \\
 U26 &= 0.9D + 1.5S \\
 U27 &= 0.9D + 1.5S + 1.5H \\
 U28 &= 0.9D + 0.5L + 1.5S \\
 U29 &= 0.9D + 0.5L + 1.5S + 1.5H \\
 U30 &= 0.9D + 1.5S + 0.4W \\
 U31 &= 0.9D + 1.5S + 0.4W + 1.5H \\
 U32 &= 0.9D + 1.5S - 0.4W \\
 U33 &= 0.9D + 1.5S - 0.4W + 1.5H \\
 U34 &= 1.25D + 1.4W \\
 U35 &= 1.25D + 1.4W + 1.5H \\
 U36 &= 1.25D + 0.5L + 1.4W \\
 U37 &= 1.25D + 0.5L + 1.4W + 1.5H \\
 U38 &= 1.25D + 0.5S + 1.4W \\
 U39 &= 1.25D + 0.5S + 1.4W + 1.5H \\
 U40 &= 1.25D - 1.4W \\
 U41 &= 1.25D - 1.4W + 1.5H \\
 U42 &= 1.25D + 0.5L - 1.4W \\
 U43 &= 1.25D + 0.5L - 1.4W + 1.5H \\
 U44 &= 1.25D + 0.5S - 1.4W \\
 U45 &= 1.25D + 0.5S - 1.4W + 1.5H \\
 U46 &= 0.9D + 1.4W \\
 U47 &= 0.9D + 1.4W + 1.5H \\
 U48 &= 0.9D + 0.5L + 1.4W \\
 U49 &= 0.9D + 0.5L + 1.4W + 1.5H \\
 U50 &= 0.9D + 0.5S + 1.4W \\
 U51 &= 0.9D + 0.5S + 1.4W + 1.5H \\
 U52 &= 0.9D - 1.4W \\
 U53 &= 0.9D - 1.4W + 1.5H \\
 U54 &= 0.9D + 0.5L - 1.4W
 \end{aligned}$$

$$U55 = 0.9D + 0.5L - 1.4W + 1.5H$$

$$U56 = 0.9D + 0.5S - 1.4W$$

$$U57 = 0.9D + 0.5S - 1.4W + 1.5H$$

$$U58 = 1.0D + 1.0E$$

$$U59 = 1.0D + 1.0L + 0.25S + 1.0E$$

$$U60 = 1.0D - 1.0E$$

$$U61 = 1.0D + 1.0L + 0.25S - 1.0E$$

For CSA A23.3-94

- Service load combinations³³

$$S1 = 1.0D$$

$$S2 = 1.0D + 1.0L + 1.0S + 1.0H$$

$$S3 = 1.0D + 1.0W$$

$$S4 = 1.0D - 1.0W$$

$$S5 = 1.0D + 0.7L + 0.7S + 0.7W + 0.7H$$

$$S6 = 1.0D + 0.7L + 0.7S - 0.7W + 0.7H$$

- Ultimate load combinations³⁴

$$U1 = 1.25D$$

$$U2 = 1.25D + 1.5L$$

$$U3 = 1.25D + 1.5L + 1.5S$$

$$U4 = 1.25D + 1.5L + 1.5S + 1.5H$$

$$U5 = 1.25D + 1.5W$$

$$U6 = 1.25D - 1.5W$$

$$U7 = 1.25D + 1.05L + 1.05W$$

$$U8 = 1.25D + 1.05L + 1.05S + 1.05W$$

$$U9 = 1.25D + 1.05L + 1.05S + 1.05W + 1.05H$$

$$U10 = 1.25D + 1.05L - 1.05W$$

$$U11 = 1.25D + 1.05L + 1.05S - 1.05W$$

$$U12 = 1.25D + 1.05L + 1.05S - 1.05W + 1.05H$$

$$U13 = 0.85D + 1.5L$$

$$U14 = 0.85D + 1.5L + 1.5S$$

$$U15 = 0.85D + 1.5L + 1.5S + 1.5H$$

$$U16 = 0.85D + 1.5W$$

$$U17 = 0.85D - 1.5W$$

$$U18 = 0.85D + 1.05L + 1.05W$$

$$U19 = 0.85D + 1.05L + 1.05S + 1.05W$$

$$U20 = 0.85D + 1.05L + 1.05S + 1.05W + 1.05H$$

$$U21 = 0.85D + 1.05L - 1.05W$$

$$U22 = 0.85D + 1.05L + 1.05S - 1.05W$$

$$U23 = 0.85D + 1.05L + 1.05S - 1.05W + 1.05H$$

$$U24 = 1.0D + 1.0E$$

³³ CSA A23.3-94, 8.3.3; NBCC 95, 4.1.3.3.2

³⁴ CSA A23.3-94, 8.3.2

$$U25 = 1.0D - 1.0E$$

$$U26 = 1.0D + 1.0L + 1.0E$$

$$U27 = 1.0D + 1.0L + 1.0S + 1.0E$$

$$U28 = 1.0D + 1.0L + 1.0S + 1.0E + 1.0H$$

$$U29 = 1.0D + 1.0L - 1.0E$$

$$U30 = 1.0D + 1.0L + 1.0S - 1.0E$$

$$U31 = 1.0D + 1.0L + 1.0S - 1.0E + 1.0H$$

Import File Formats

Grid, load, and load combination data may be imported from a text file. The import file must be saved in pure ASCII (text) format. Data fields on each line should be separated by spaces or TABs. Comments or blank lines should not be placed within the import file. The first line of each text file must be the unique keyword associated with the input.

Grid Data:

```

GRID
N_X
X_1
X_2
...
X_N_X
N_Y
Y_1
Y_2
...
Y_N_Y

```

Where:

GRID	=	keyword required
N_X	=	number of X gridlines
X_i	=	i'th X gridline coordinate with i=1 to N_X
N_Y	=	number of Y gridlines
Y_j	=	j'th Y gridline coordinate with j=1 to N_Y

Load Data:

```

LOADS
N_P
Label_P_1 Case_P_1 Px_1 Py_1 Pz_1 Mx_1 My_1 Mz_1 Ec_1
Label_P_2 Case_P_2 Px_2 Py_2 Pz_2 Mx_2 My_2 Mz_2 Ec_2
...
Label_P_N Case_P_N Px_N Py_N Pz_N Mx_N My_N Mz_N Ec_N
N_A
Label_A_1 Case_A_1 Wx_1 Wy_1 Wz_1
Label_A_2 Case_A_2 Wx_2 Wy_2 Wz_2
...
Label_A_N Case_A_N Wx_N Wy_N Wz_N
N_LA
Label_LA_1 Case_LA_1 Y1_1 Y2_1 Wx_Y1_1 Wy_Y1_1 Wz_Y1_1 Wx_Y2_1 Wy_Y2_1
Wz_Y2_1
Label_LA_2 Case_LA_2 Y1_2 Y2_2 Wx_Y1_2 Wy_Y1_2 Wz_Y1_2 Wx_Y2_2 Wy_Y2_2
Wz_Y2_2
...
Label_LA_N Case_LA_N Y1_N Y2_N Wx_Y1_N Wy_Y1_N Wz_Y1_N Wx_Y2_N Wy_Y2_N
Wz_Y2_N
N_LL
Label_LL_1 Case_LL_1 Wx_1 Wy_1 Wz_1 Ec_1
Label_LL_2 Case_LL_2 Wx_2 Wy_2 Wz_1 Ec_2
...
Label_LL_N Case_LL_N Wx_N Wy_N Wz_N Ec_N

```

Where:

LOADS	=	keyword required
N_P	=	number of point loads
Label_PL_i	=	label of the i'th point load, with i=1 to N_P
Case_P_S_i	=	name of the load case to which the i'th point is assigned
Px_i	=	Px force component of the i'th point load
Py_i	=	Py force component of the i'th point load
Pz_i	=	Pz force component of the i'th point load

Mx _i	=	Mx moment component of the i'th point load
My _i	=	My moment component of the i'th point load
Mz _i	=	Mz moment component of the i'th point load
Ec _i	=	eccentricity of the i'th point load
N _A	=	number of uniform area loads
Label _A	=	number of uniform area loads
Label _{A_j}	=	label of the j'th uniform area load, with j=1 to N _A
Case _{A_j}	=	name of the load case to which the j'th uniform area load is assigned
Wx _j	=	Wx force component of the j'th uniform area load
Wy _j	=	Wy force component of the j'th uniform area load
Wz _j	=	Wz force component of the j'th uniform area load
N _{LA}	=	number of linear area loads
Label _{LA_k}	=	label of the k'th linear area load, with k=1 to N _{LA}
Case _{LA_k}	=	name of the load case to which the k'th linear area load is assigned
Y1 _k	=	Y1 coordinate of the k'th linear area load
Y2 _k	=	Y2 coordinate of the k'th linear area load
Wx _{Y1_k}	=	Wx force component of the k'th uniform area load at coordinate Y1
Wy _{Y1_k}	=	Wy force component of the k'th uniform area load at coordinate Y1
Wz _{Y1_k}	=	Wz force component of the k'th uniform area load at coordinate Y1
Wx _{Y2_k}	=	Wx force component of the k'th uniform area load at coordinate Y2
Wy _{Y2_k}	=	Wy force component of the k'th uniform area load at coordinate Y2
Wz _{Y2_k}	=	Wz force component of the k'th uniform area load at coordinate Y2
N _{LL}	=	number of uniform line loads
Label _{LL_m}	=	label of the m'th uniform line load, with m=1 to N _{LL}
Case _{LL_m}	=	name of the load case to which the m'th uniform area load is assigned
Wx _m	=	Wx force component of the m'th uniform line load
Wy _m	=	Wy force component of the m'th uniform line load
Wz _m	=	Wz force component of the m'th uniform line load

Load Combination Data:

```

COMBINATIONS
Self
N_C
N_S
Label_S_1 CaseA_S_1 CaseB_S_1 CaseC_S_1 CaseD_S_1 CaseE_S_1 CaseF_S_1
Label_S_2 CaseA_S_2 CaseB_S_2 CaseC_S_2 CaseD_S_2 CaseE_S_2 CaseF_S_2
...
Label_S_N CaseA_S_N CaseB_S_N CaseC_S_N CaseD_S_N CaseE_S_N CaseF_S_N
N_U
Label_U_1 CaseA_U_1 CaseB_U_1 CaseC_U_1 CaseD_U_1 CaseE_U_1 CaseF_U_1
Label_U_2 CaseA_U_2 CaseB_U_2 CaseC_U_2 CaseD_U_2 CaseE_U_2 CaseF_U_2
...
Label_U_N CaseA_U_N CaseB_U_N CaseC_U_N CaseD_U_N CaseE_U_N CaseF_U_N

```

Where:

COMBINATIONS	=	keyword required
Self	=	1 if self weight is to be automatically included in Case A, 0 otherwise
N _C	=	number of load cases per combination (maximum 6, A through F)
N _S	=	number of service load combinations
Label _{S_i}	=	label of the i'th service load combination, with i=1 to N _S
Case _{j_S_i}	=	factor assigned to j'th load case in the i'th service load combination with j=A to F and i=1 to N _S
N _U	=	number of ultimate load combinations
Label _{U_k}	=	label of the k'th service load combination, with k=1 to N _U
Case _{j_S_k}	=	factor assigned to j'th load case in the k'th service load combination with j=A to F and k=1 to N _U

Conversion Factors - English to SI

To convert from	To	Multiply by
in.	m (1000 mm)	0.025400
ft	m	0.304800
lb	N (0.001 kN)	4.448222
kip (1000 lbs)	kN	4.448222
plf (lb/ft)	N/m	14.593904
psi (lb/in. ²)	kPa	6.894757
ksi (kips/in. ²)	MPa	6.894757
psf (lb/ft ²)	N/m ² (Pa)	47.88026
pcf (lb/ft ³)	kg/m ³	16.018460
ft-kips	kN • m	1.355818

Conversion Factors - SI to English.

To convert from	To	Multiply by
m (1000 mm)	in	39.37008
m	ft	3.28084
N (0.001 kN)	lb	0.224809
kN	kip (1000 lbs)	0.224809
kN/m	plf (lb/ft)	68.52601
MPa	psi (lb/in. ²)	145.0377
MPa	ksi (kips/in. ²)	0.145038
kN/m ² (kPa)	psf (lb/ft ²)	20.88555
kg/m ³	pcf (lb/ft ³)	0.062428
kN • m	ft-kips	0.737562

Contact Information

Web Site: <http://www.StructurePoint.org>

E-mail: info@StructurePoint.org
support@StructurePoint.org

Address: StructurePoint, LLC
5420 Old Orchard Road
Skokie, IL 60077
USA

Phone: (847) 966-4357

Fax: (847) 966-1542